

Ventilated
Aluminium support system for
TIMBER / BOARD CLADDING

LEGEND:

- A – cladding
- B – joint profile
- C – clamp
- D – corner-profile
- F – window profile
- 1 – Wall
- 2 – NVELOPE – support bracket
- 3 – Stainless steel fixing
- 4 – Self drilling stainless steel screw SR2 4.2 x 16
- 5 – Vertical Timber Batten
- 6 – Thermal insulation
- 7 – Ventilation
- 8 – Uni-carrier
- 9 – NVELOPE Thermal isolator
- 10 – Timber fixing screw

CONTENTS:

- NV6 – 01 Tolerances for adjustment
- NV6 – 02 View of cladding drawing locations – Timber cladding
- NV6 – 03 View of cladding – Timber cladding
- NV6 – 04 Horizontal section – NVELOPE 90 with T100 carrier
- NV6 – 05 Vertical section – Base of cladding
- NV6 – 06 Vertical section – Head of cladding
- NV6 – 07 Horizontal section – Window return detail
- NV6 – 08 Vertical section – Window sill detail.
- NV6 – 09 Vertical section – Window Head detail
- NV6 – 10 Horizontal section – External Corner
- NV6 – 10A Horizontal section – Internal Corner
- NV6 – 10B Horizontal section – External Corner

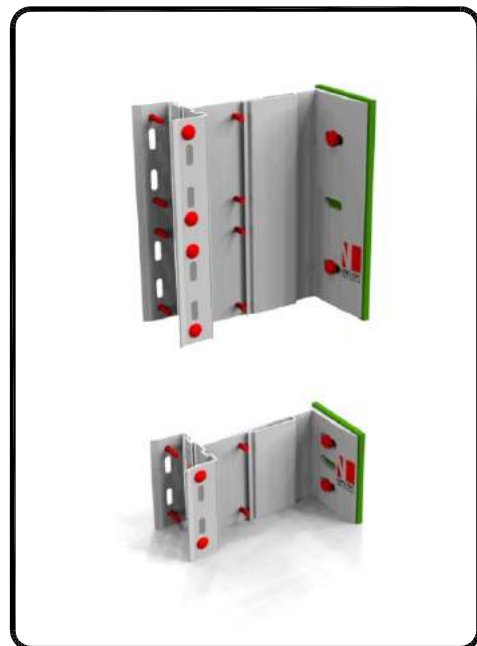
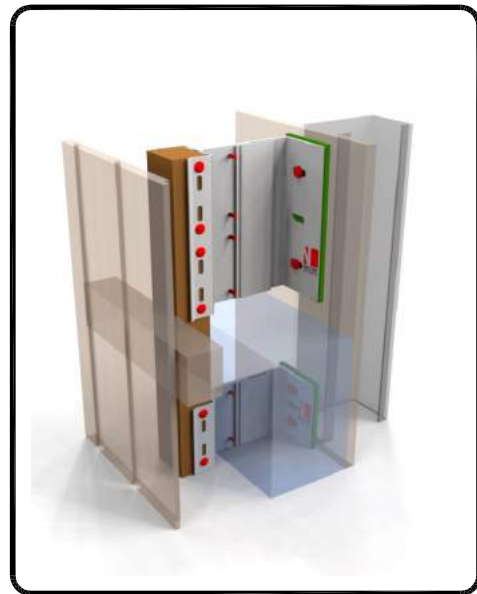

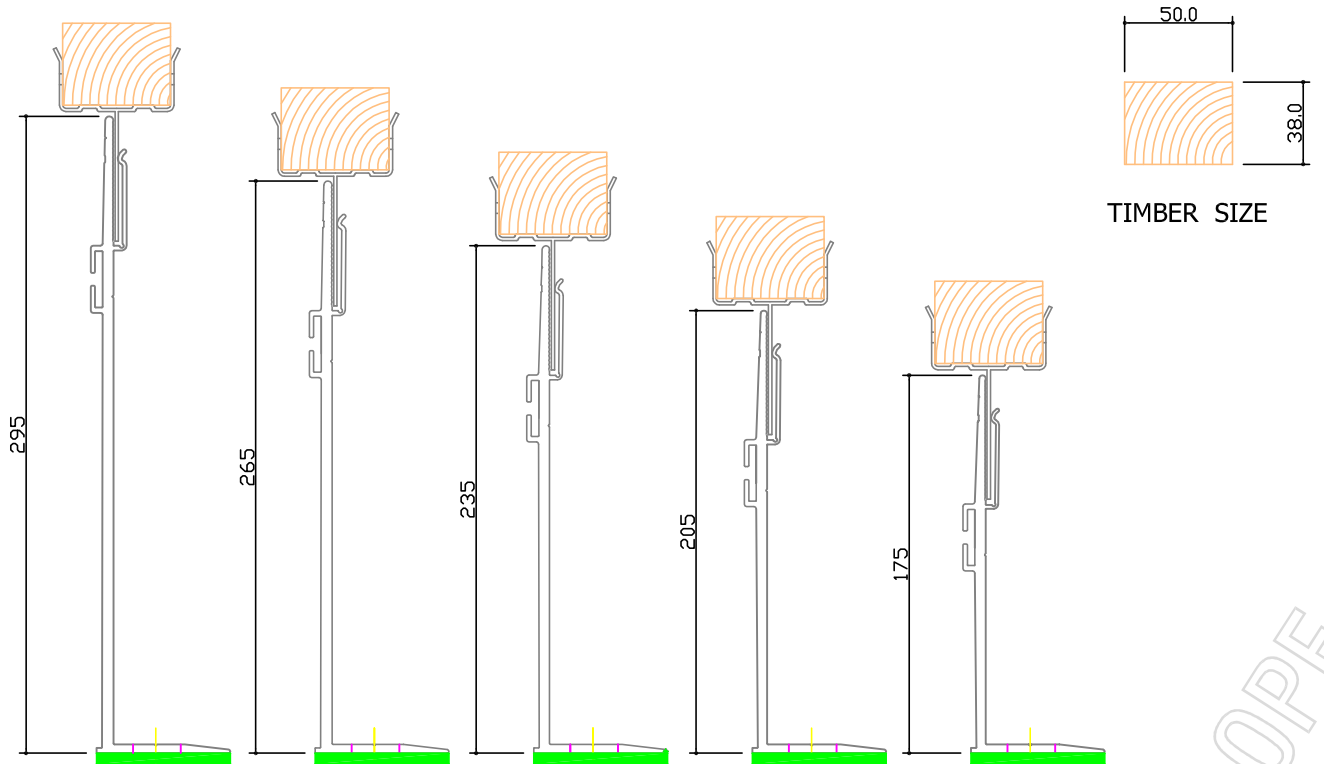

ADJUSTMENT 343mm-383mm ADJUSTMENT 313mm-353mm ADJUSTMENT 283mm-323mm ADJUSTMENT 253mm-293mm ADJUSTMENT 223mm-263mm

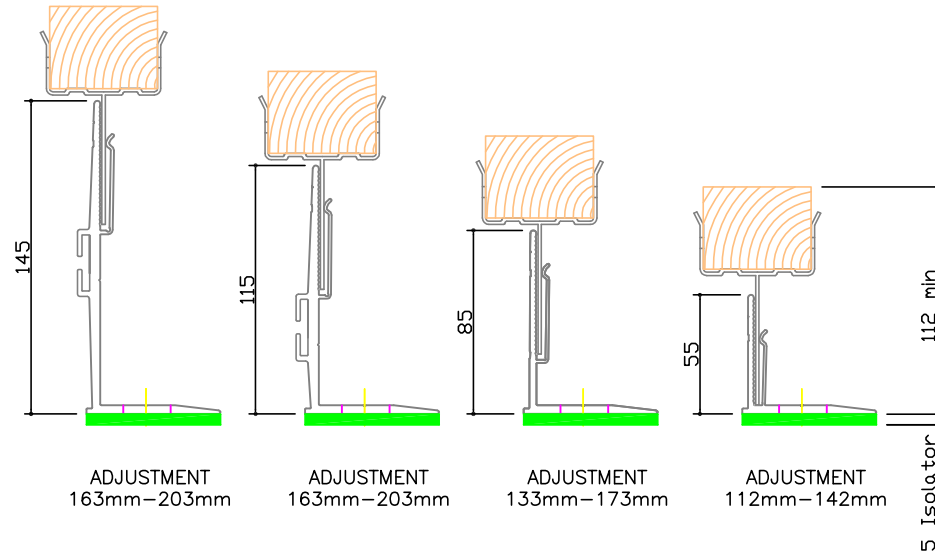

ADJUSTMENT 163mm-203mm ADJUSTMENT 163mm-203mm ADJUSTMENT 133mm-173mm ADJUSTMENT 112mm-142mm

5 Isolator

**HORIZONTAL SECTIONS
TOLERANCES FOR ADJUSTMENT**

BRACKETS	Adjustment range for each bracket (mm)		Based on a 50 x 38 timber
Nvelope 60	from 112	to 142	
Nvelope 90	from 133	to 173	
Nvelope 120	from 163	to 203	
Nvelope 150	from 193	to 233	
Nvelope 180	from 223	to 263	
Nvelope 210	from 253	to 293	
Nvelope 240	from 283	to 323	
Nvelope 270	from 313	to 353	
Nvelope 300	from 343	to 383	

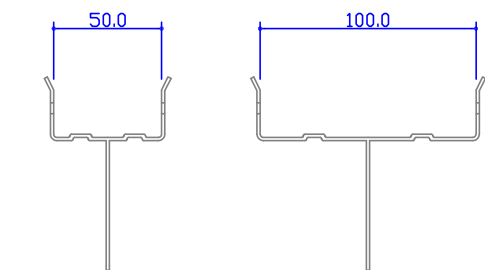

CARRIER AVAILABLE IN
75mm-150mm LENGTHS
TO SUIT DOUBLE AND SINGLE BRACKET SIZES

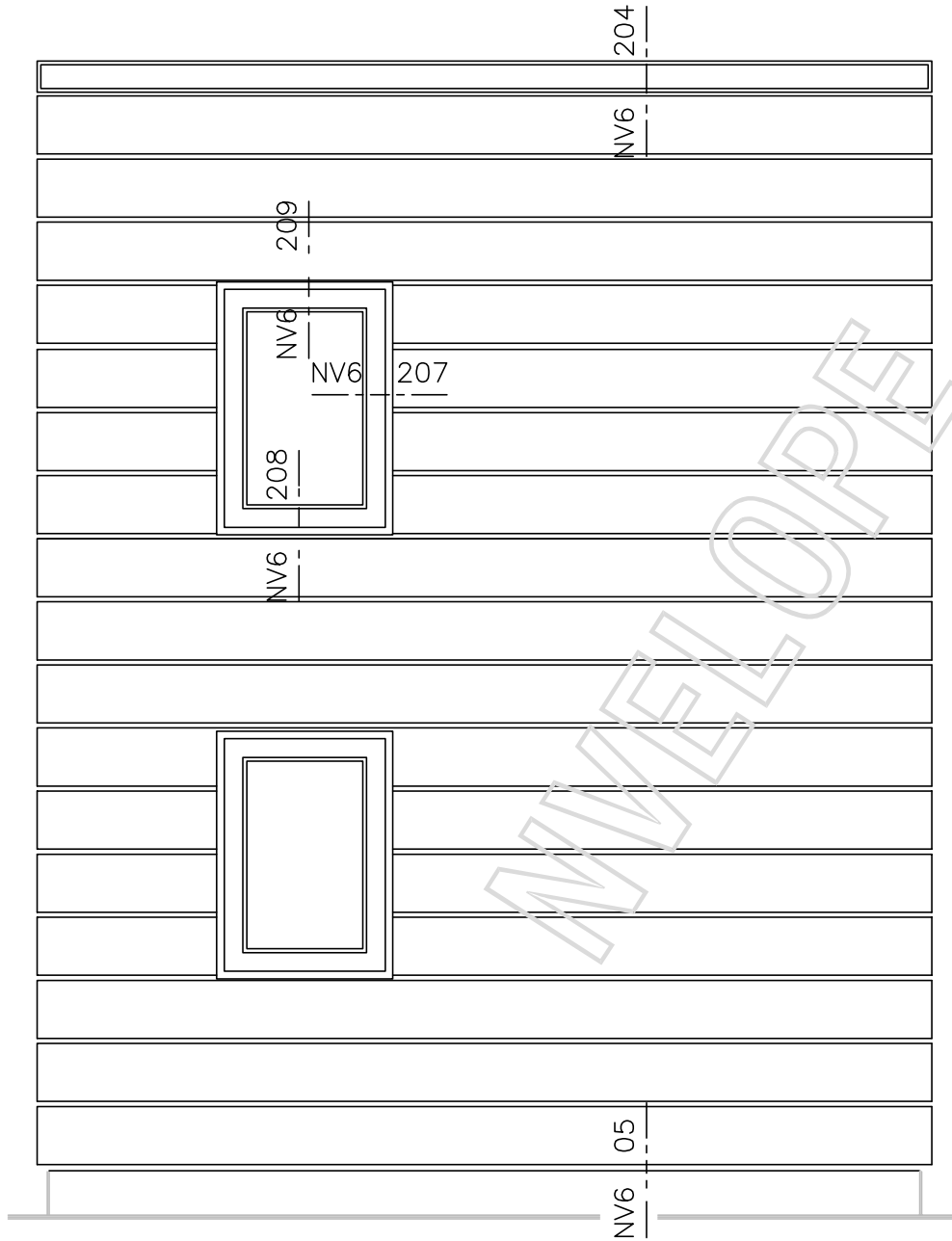

VIEW OF CLADDING

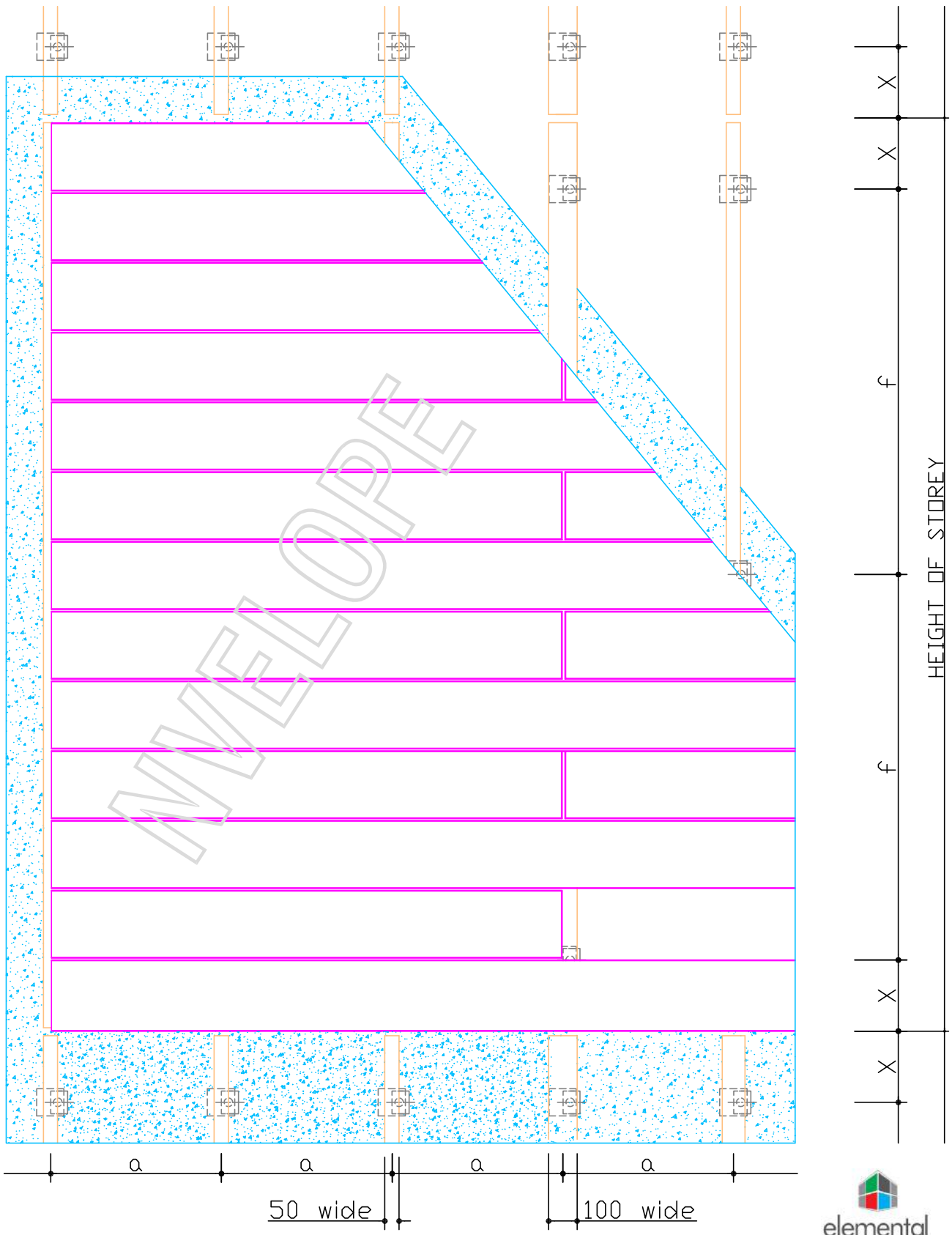

VIEW OF CLADDING

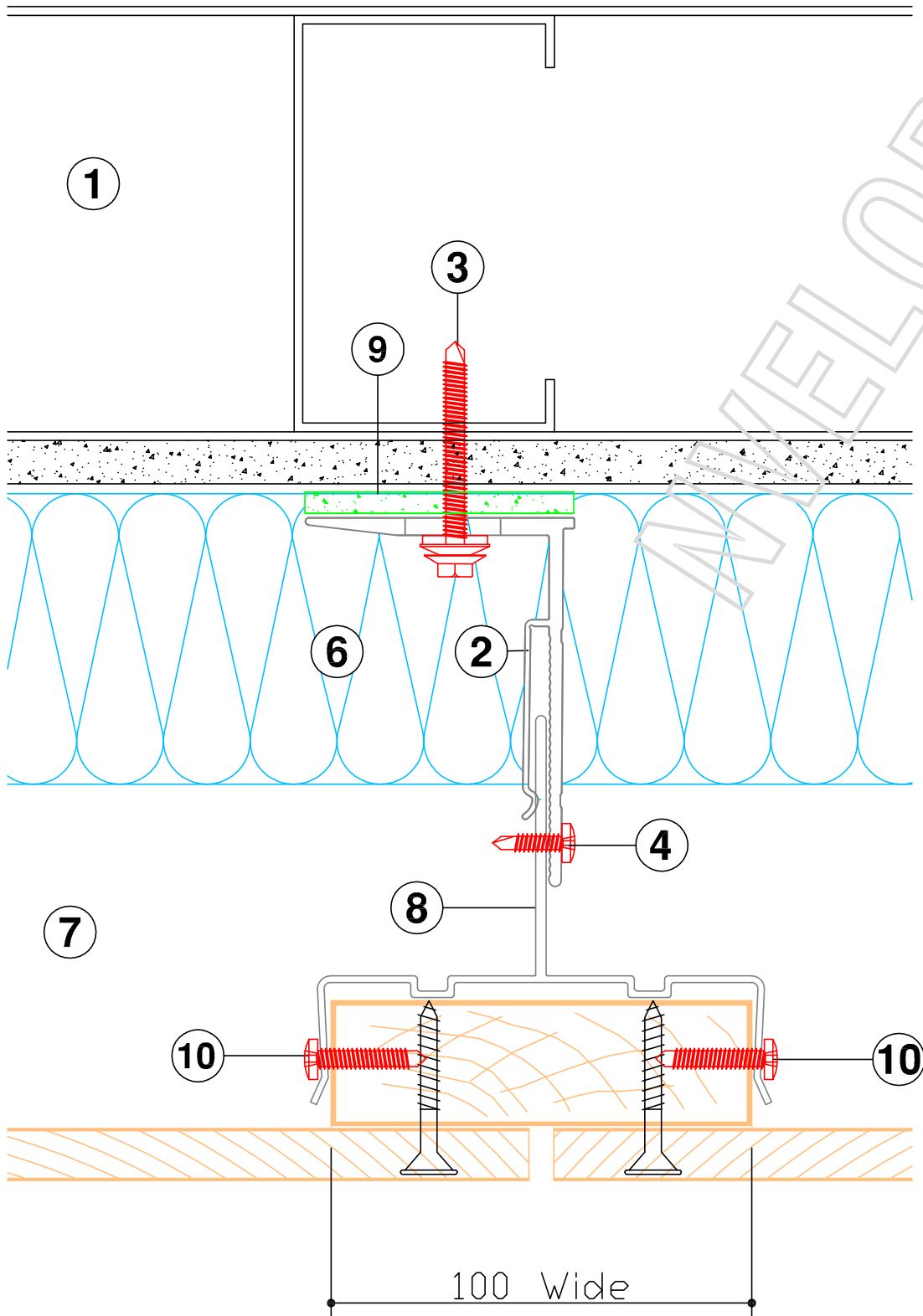

HORIZONTAL JOINT SECTION - NVELOPE 90 WITH T100 CARRIER

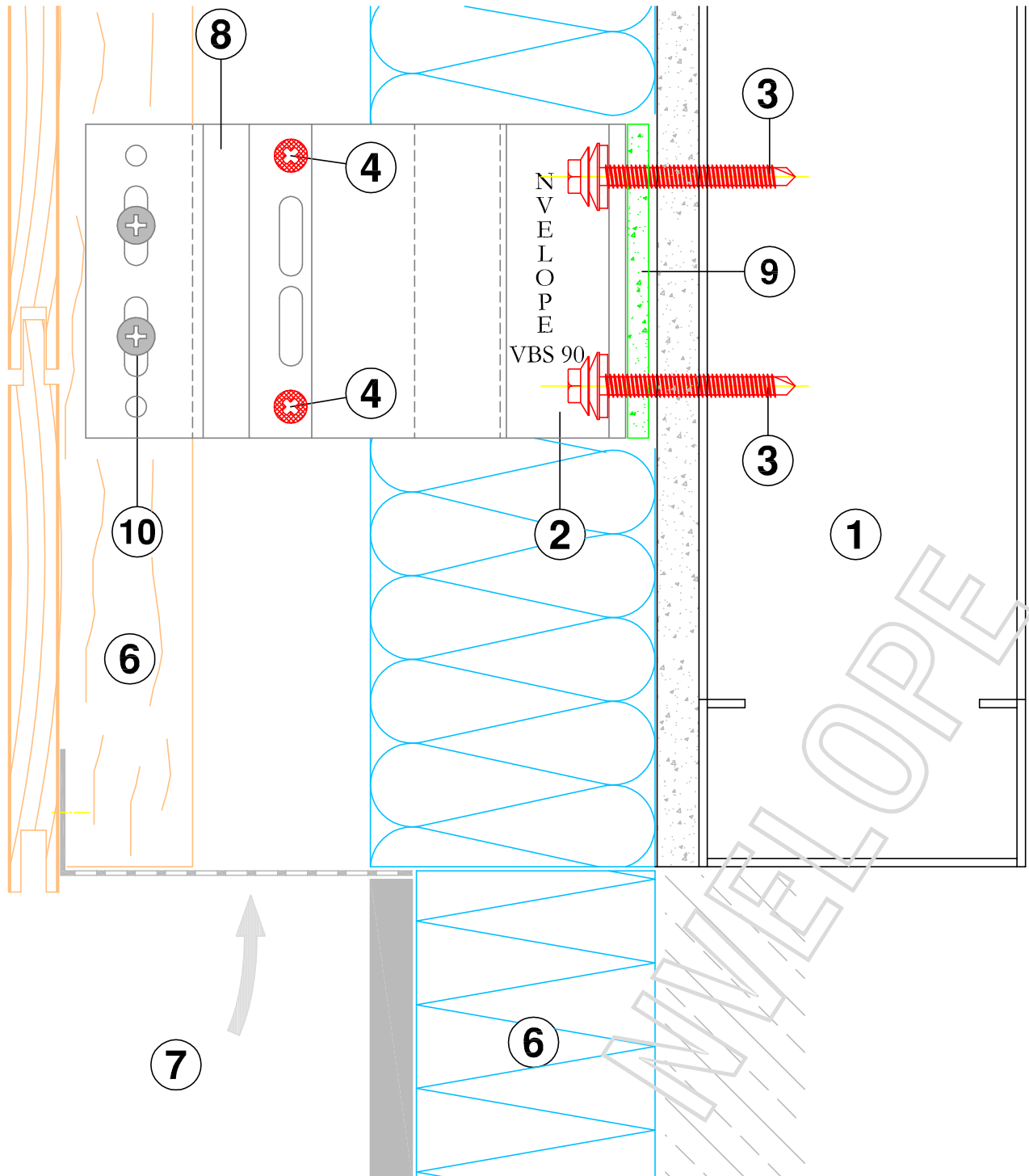

VERTICAL SECTION - BASE DETAIL

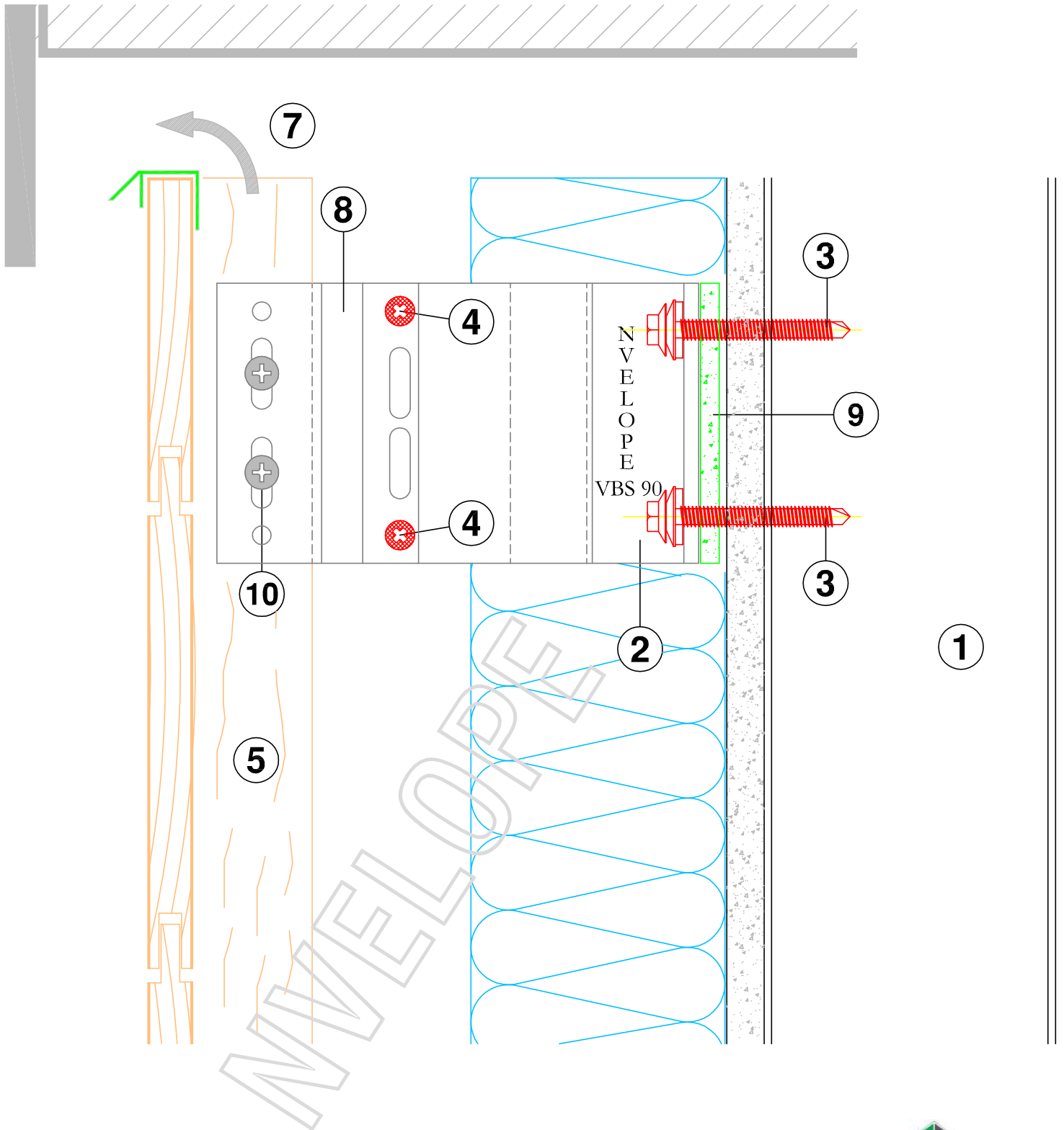

VERTICAL SECTION - HEAD DETAIL

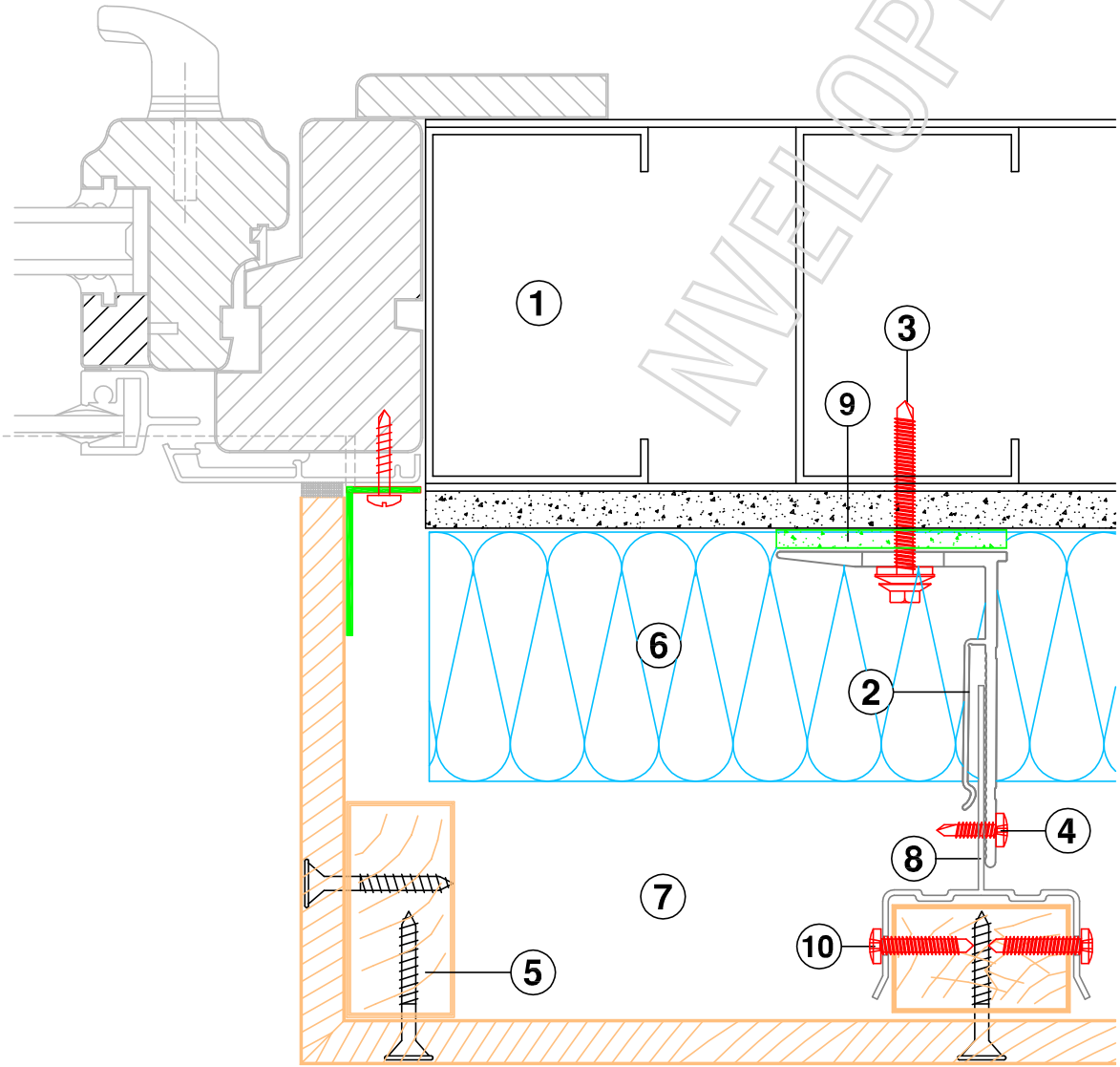

HORIZONTAL SECTION - WINDOW DETAIL

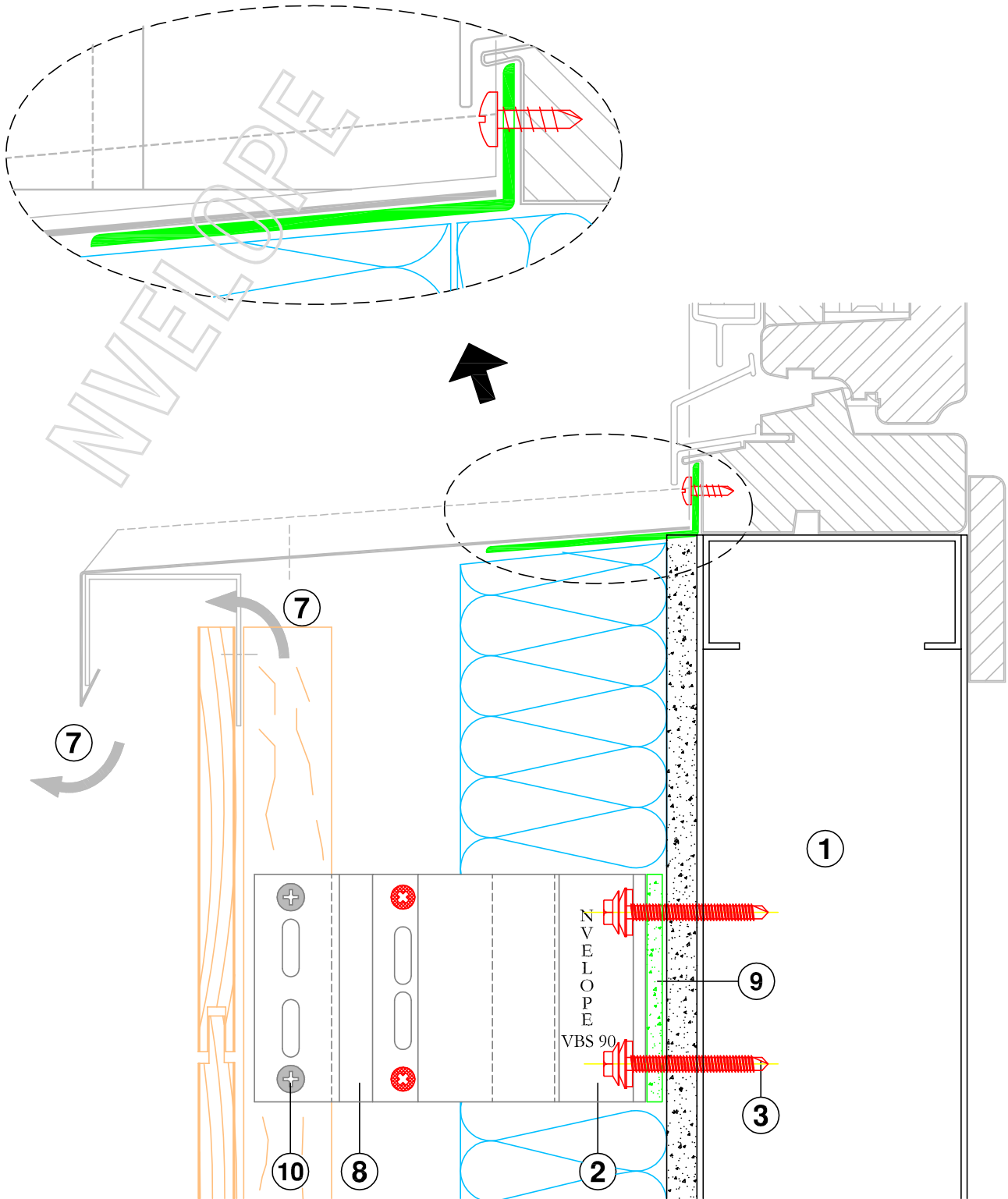

VERTICAL SECTION - WINDOW SILL DETAIL

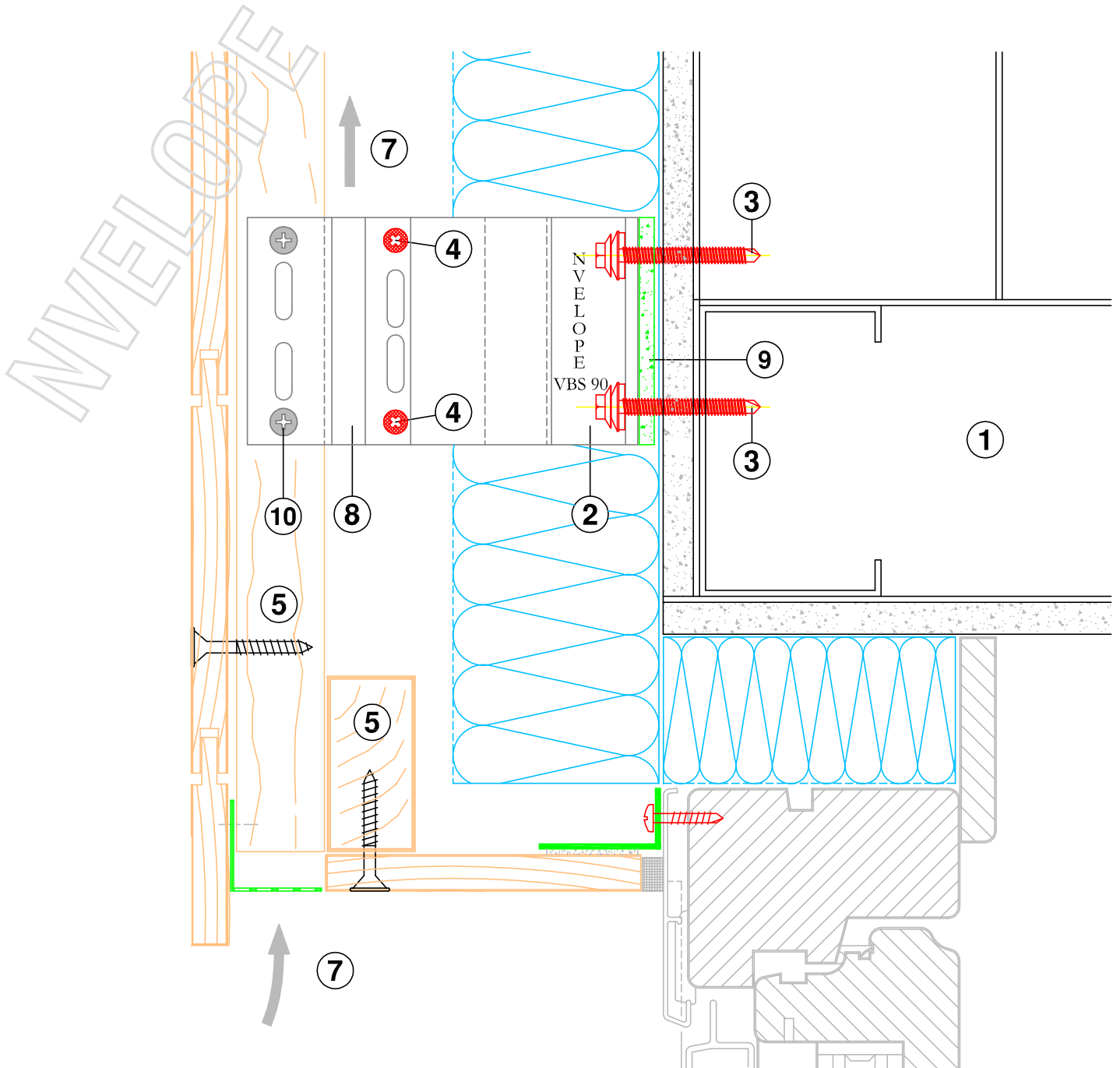

VERTICAL SECTION - WINDOW HEAD DETAIL

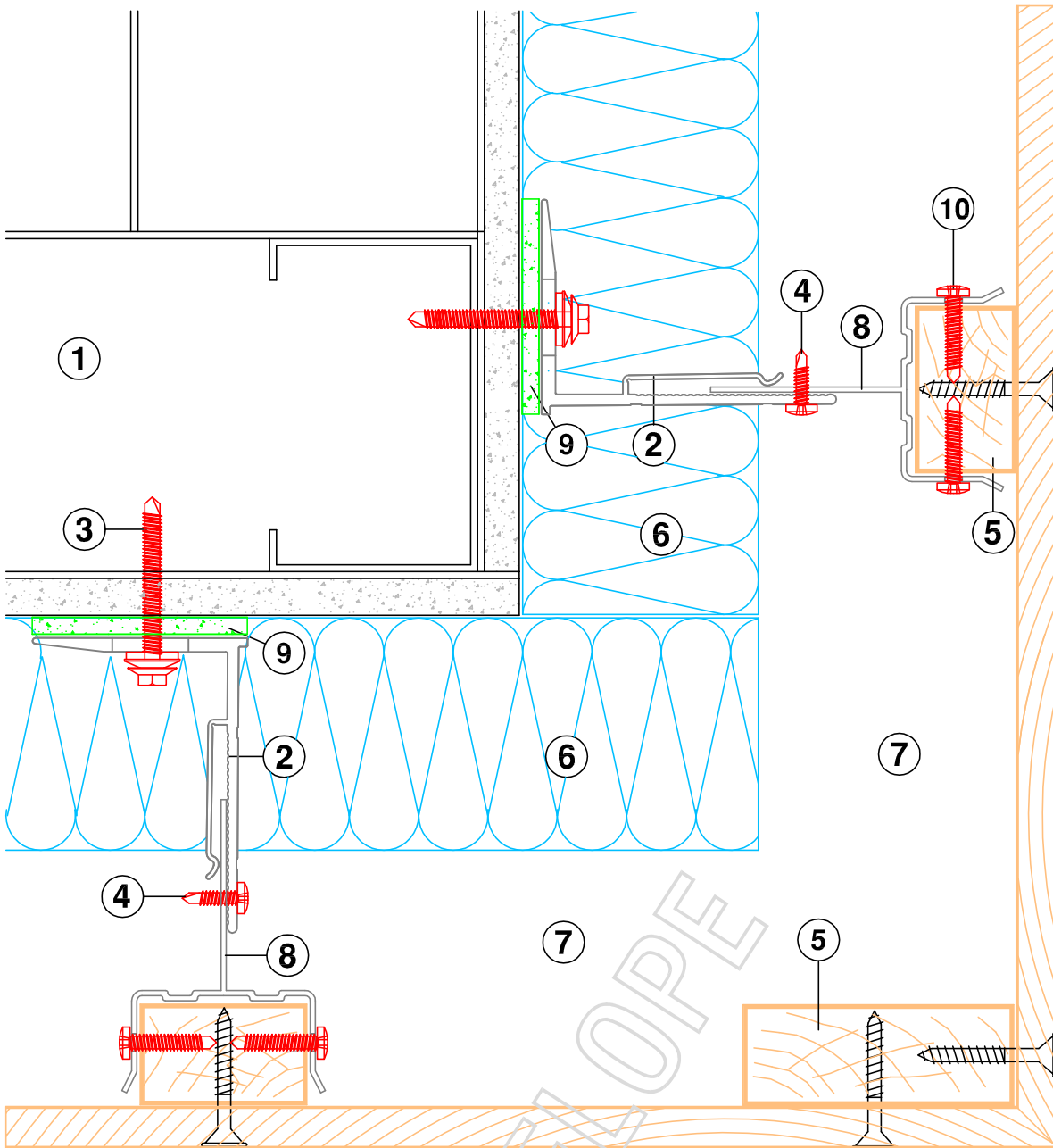

HORIZONTAL SECTION - EXTERNAL CORNER

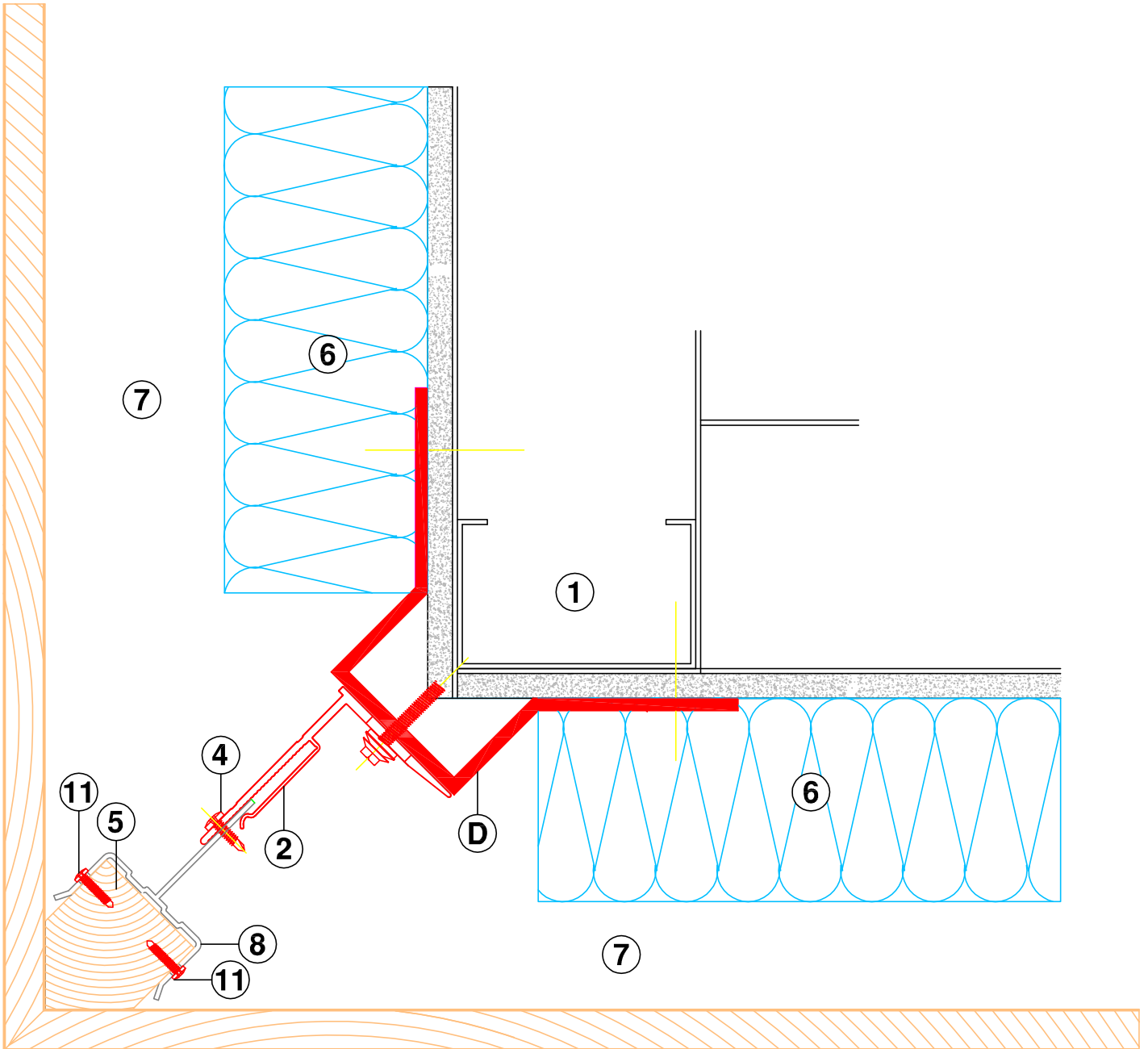

(Special section of timber by other)

HORIZONTAL SECTION - EXTERNAL CORNER