

Facade System

Ventilated facade

EL-SB-SHMD

Elemental-SFS Bracket-Screw Horizontal Metal Deck

HORIZONTAL METAL DECK

Face Fix onto 1- Layer - Metal substructure

Contents:

EL-SB-SHMD01	SYSTEM LAYOUT
EL-SB-SHMD02	BRACKET TYPES AVAILABLE
EL-SB-SHMD03	BASE DETAIL
EL-SB-SHMD04	HORIZONTAL PANEL JOINT DETAIL
EL-SB-SHMD05	VERTICAL PANEL JOINT DETAIL
EL-SB-SHMD06	INTERMEDIATE SUPPORT DETAIL
EL-SB-SHMD07	BUILDING STRUCTURAL MOVEMENT JOINT
EL-SB-SHMD08	EXTERNAL CORNER DETAIL
EL-SB-SHMD09	INTERNAL CORNER DETAIL
EL-SB-SHMD10	GENERIC PARAPET DETAIL
EL-SB-SHMD11	WINDOW CILL DETAIL
EL-SB-SHMD12	WINDOW HEAD DETAIL
EL-SB-SHMD13	WINDOW JAMB REVEAL DETAIL

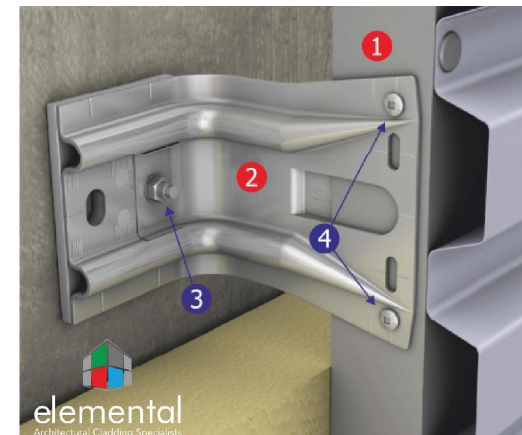

- 1 'L' or 'T' Rail
- 2 Support Bracket
- FIXINGS:**
- 3 Bracket to Wall Fixings/Anchors
- 4 Rail to Bracket Fixings

These drawings are indicative only, for use as a guide. The customer is always responsible for any specific design, structural calculations and calculating exact sizes & quantities of panels. Any project details and calculations supplied by Elemental Architectural Cladding Specialists are provided in good faith and should always be checked and approved by the project engineer responsible. Elemental Architectural Cladding Specialists will not accept any liability should the system be designed / installed incorrectly.

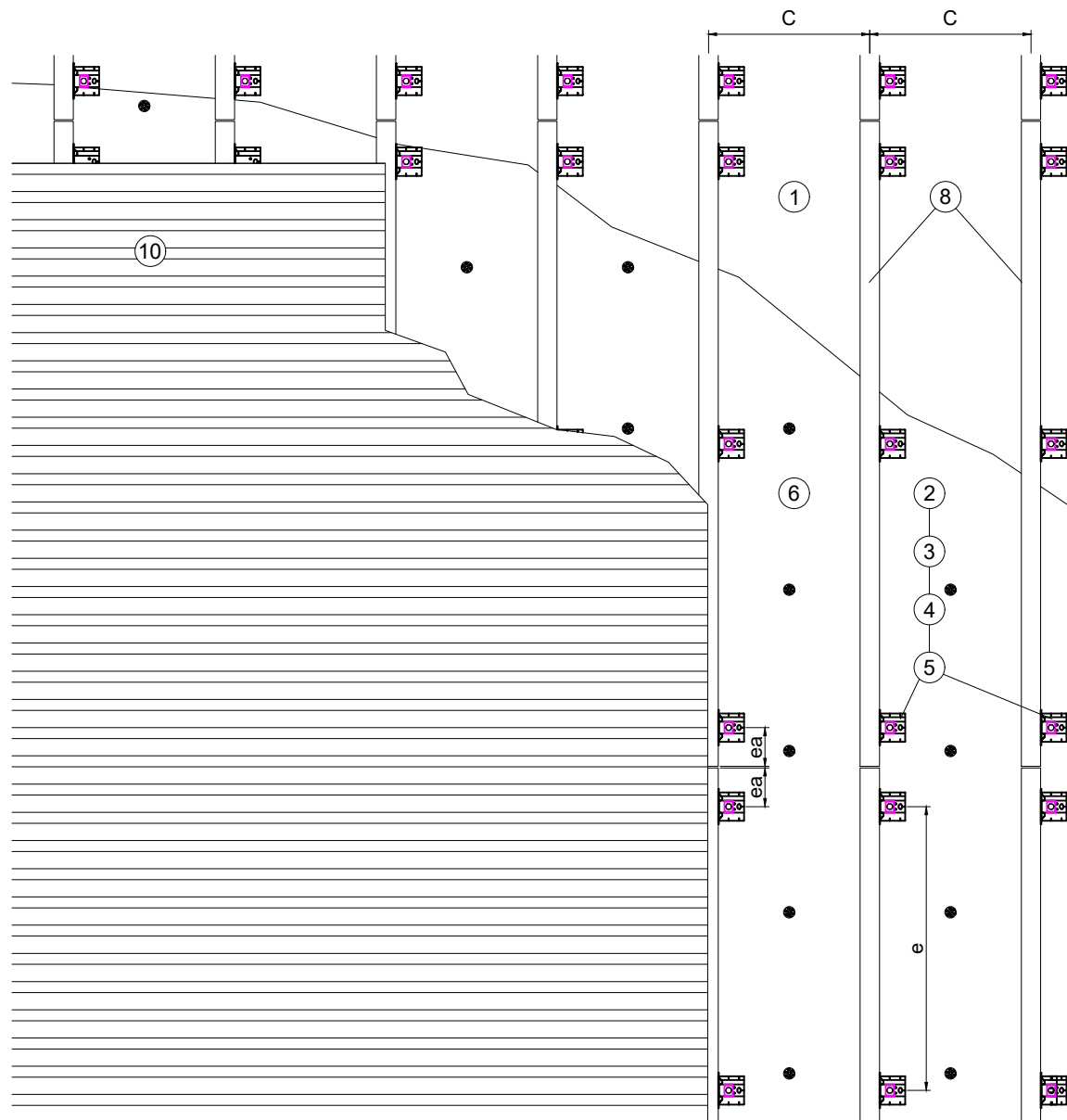

- 1... Wall
- 2... SPIDI max Thermostop (preassembled)
- 3... SPIDI max wall bracket
- 4... SPIDI max washer
- 5... Fixing element (according to wall condition)
- 6... Insulation
- 8... Support profile vertical
- 10... Facade cladding

C... profile distance
 e... brackets distance
 ea... brackets distance



Elemental Architectural Cladding Specialists
 #29 The Cubes Offices, Beacon South Quarter,
 Sandyford
 Dublin 18, D18 A264
 Phone: +353 (0)1 293 8951
 Email: info@elemental.ie

Drawing Title		ELEMENTAL METAL DECK - FACE FIX SYSTEM LAYOUT									
Drawing No.	EL-SB-SHMD01	System:	EL-Screw Metal Deck	Size:	A4	Scale:	NTS	Drawn:	V.C.	Rev.	01

BRACKET TYPES AVAILABLE FROM ELEMENTAL

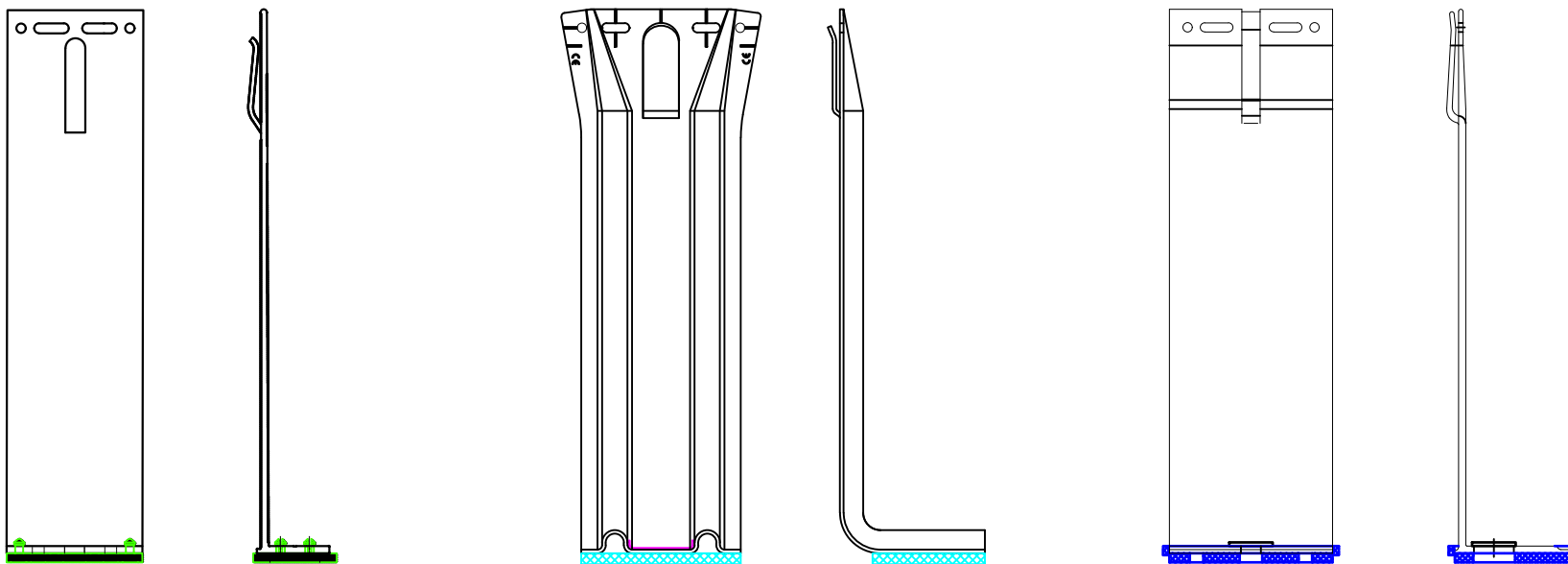

Elemental Architectural Cladding Specialists
 #29 The Cubes Offices, Beacon South Quarter,
 Sandyford
 Dublin 18, D18 A264
 Phone: +353 (0)1 293 8951
 Email: info@elemental.ie

Drawing Title	BRACKET TYPES AVAILABLE										
Drawing No.	EL-SB-SHMD02	System:	EL-Screw Metal Deck	Size:	A4	Scale:	NTS	Drawn:	V.C.	Rev.	01

These drawings are indicative only, for use as a guide. The customer is always responsible for any specific design, structural calculations and calculating exact sizes & quantities of panels. Any project details and calculations supplied by Elemental Architectural Cladding Specialists are provided in good faith and should always be checked and approved by the project engineer responsible. Elemental Architectural Cladding Specialists will not accept any liability should the system be designed / installed incorrectly.

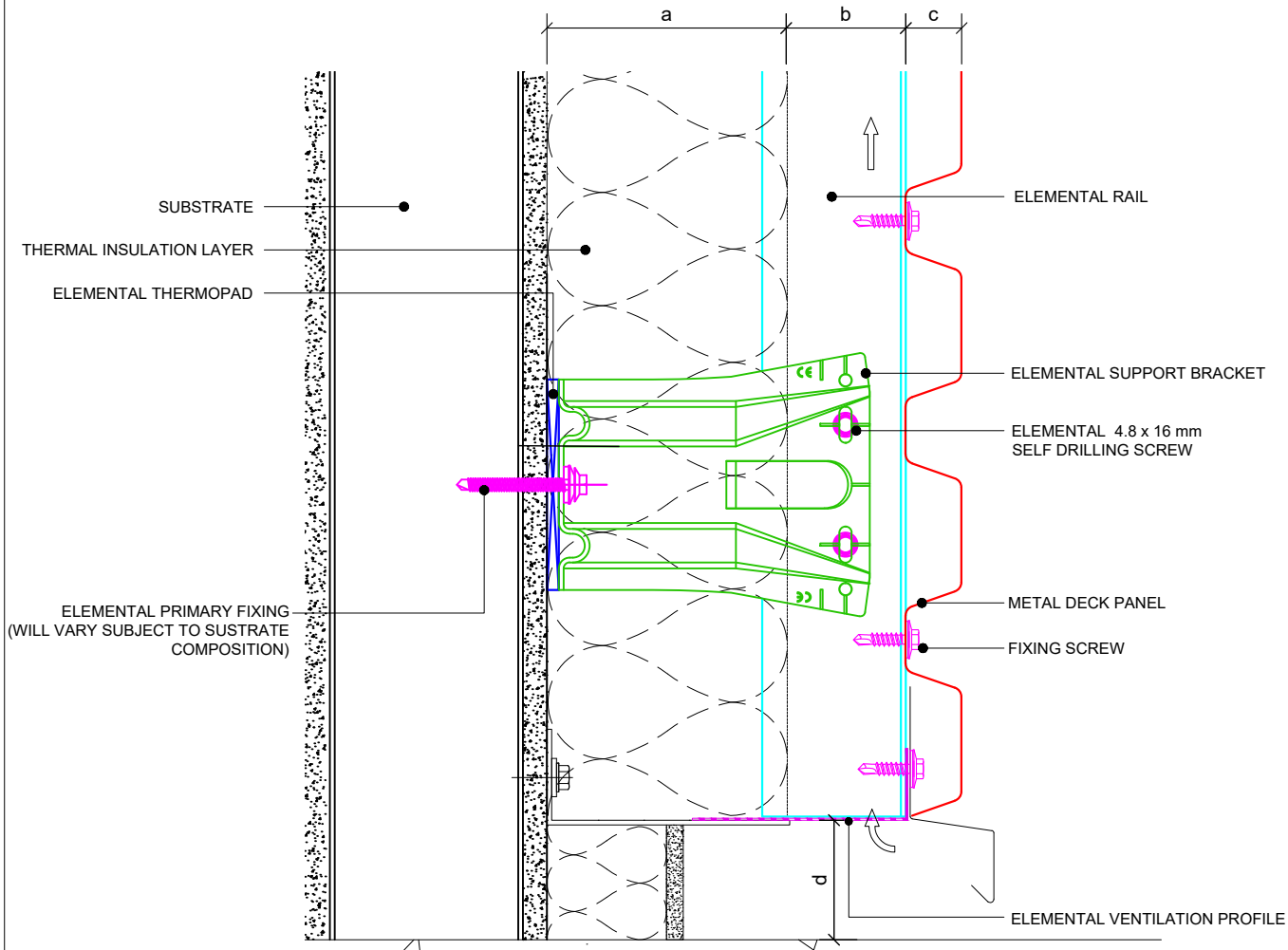

Dimensions	
a	Insulation thickness (varies)
b	Free vertical ventilation gap
c	Panel nominal thickness
d	Base distance - Minimum 50mm
a+b	Clad Zone

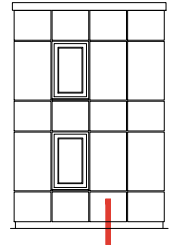

Note:

"In the event that the subframe brackets do not line up with the vertical steel studs a horizontal galvanised stud maybe required"

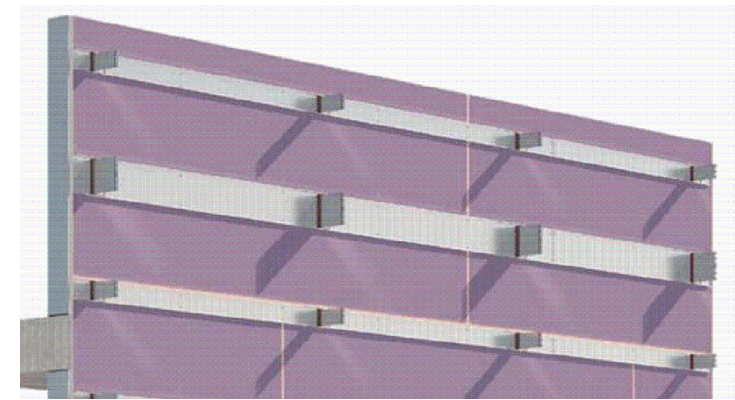
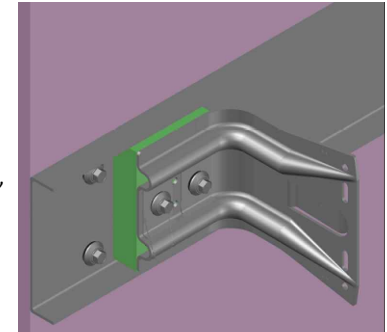

Elemental Architectural Cladding Specialists
 #29 The Cubes Offices, Beacon South Quarter,
 Sandyford
 Dublin 18, D18 A264
 Phone: +353 (0)1 293 8951
 Email: info@elemental.ie

Drawing Title		ELEMENTAL METAL DECK - FACE FIX BASE DETAIL									
Drawing No.	EL-SB-SHMD03	System:	EL-Screw Metal Deck	Size:	A4	Scale:	NTS	Drawn:	V.C.	Rev.	01

These drawings are indicative only, for use as a guide. The customer is always responsible for any specific design, structural calculations and calculating exact sizes & quantities of panels. Any project details and calculations supplied by Elemental Architectural Cladding Specialists are provided in good faith and should always be checked and approved by the project engineer responsible. Elemental Architectural Cladding Specialists will not accept any liability should the system be designed / installed incorrectly.

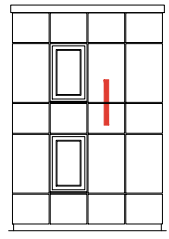
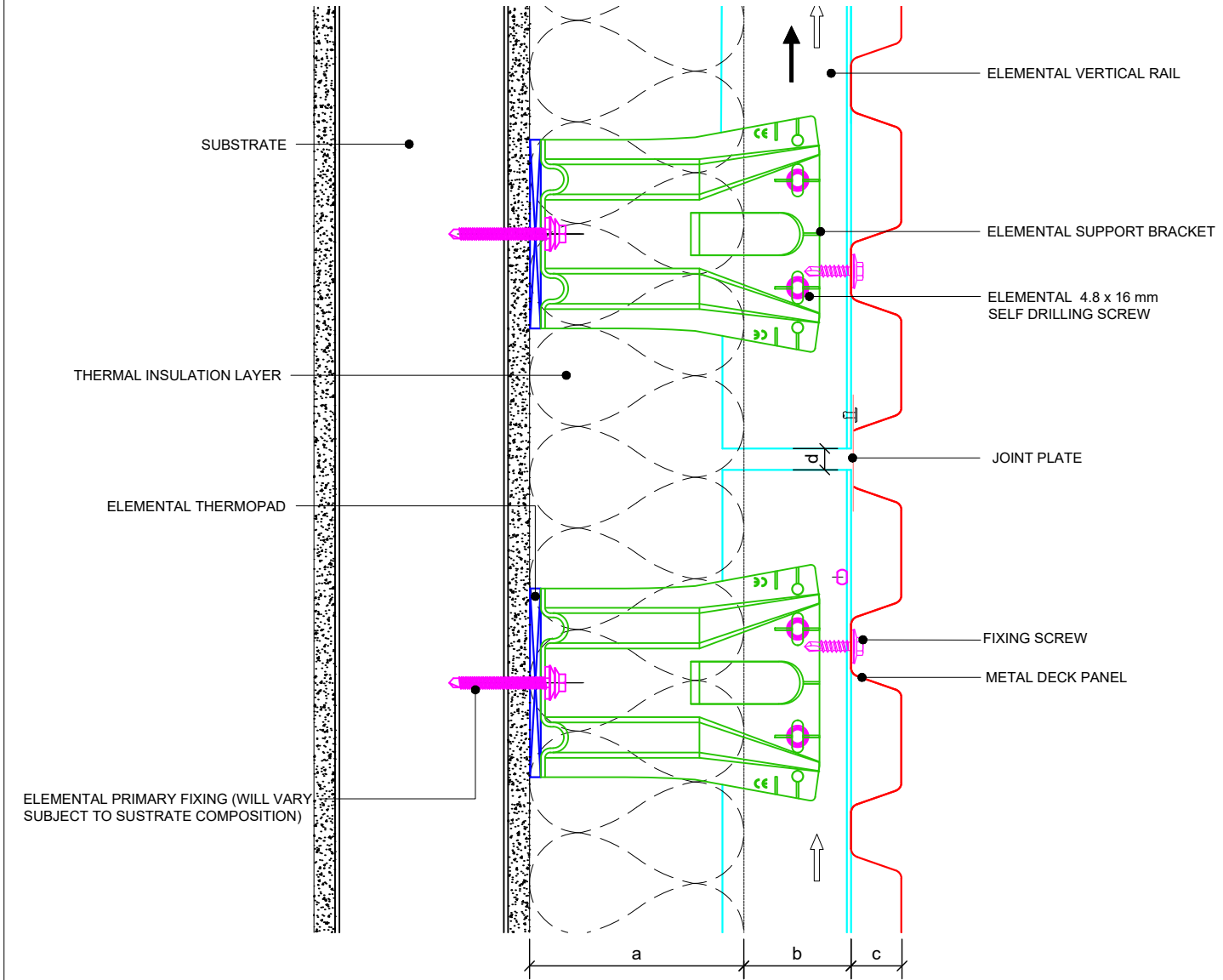

Dimensions	
a	Insulation thickness (varies)
b	Free vertical ventilation gap
c	Panel nominal thickness
d	Rail Joint - Minimum 10mm (cladding panels should not be fixed to two adjacent vertical rails)
a+b	Clad Zone

Elemental Architectural Cladding Specialists
 #29 The Cubes Offices, Beacon South Quarter,
 Sandyford
 Dublin 18, D18 A264
 Phone: +353 (0)1 293 8951
 Email: info@elemental.ie

Drawing Title	ELEMENTAL METAL DECK - FACE FIX HORIZONTAL PANEL JOINT DETAIL										
Drawing No.	EL-SB-SHMD04	System:	EL-Screw Metal Deck	Size:	A4	Scale:	NTS	Drawn:	V.C.	Rev.	01

These drawings are indicative only, for use as a guide. The customer is always responsible for any specific design, structural calculations and calculating exact sizes & quantities of panels. Any project details and calculations supplied by Elemental Architectural Cladding Specialists are provided in good faith and should always be checked and approved by the project engineer responsible. Elemental Architectural Cladding Specialists will not accept any liability should the system be designed / installed incorrectly.

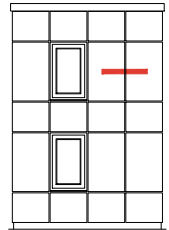
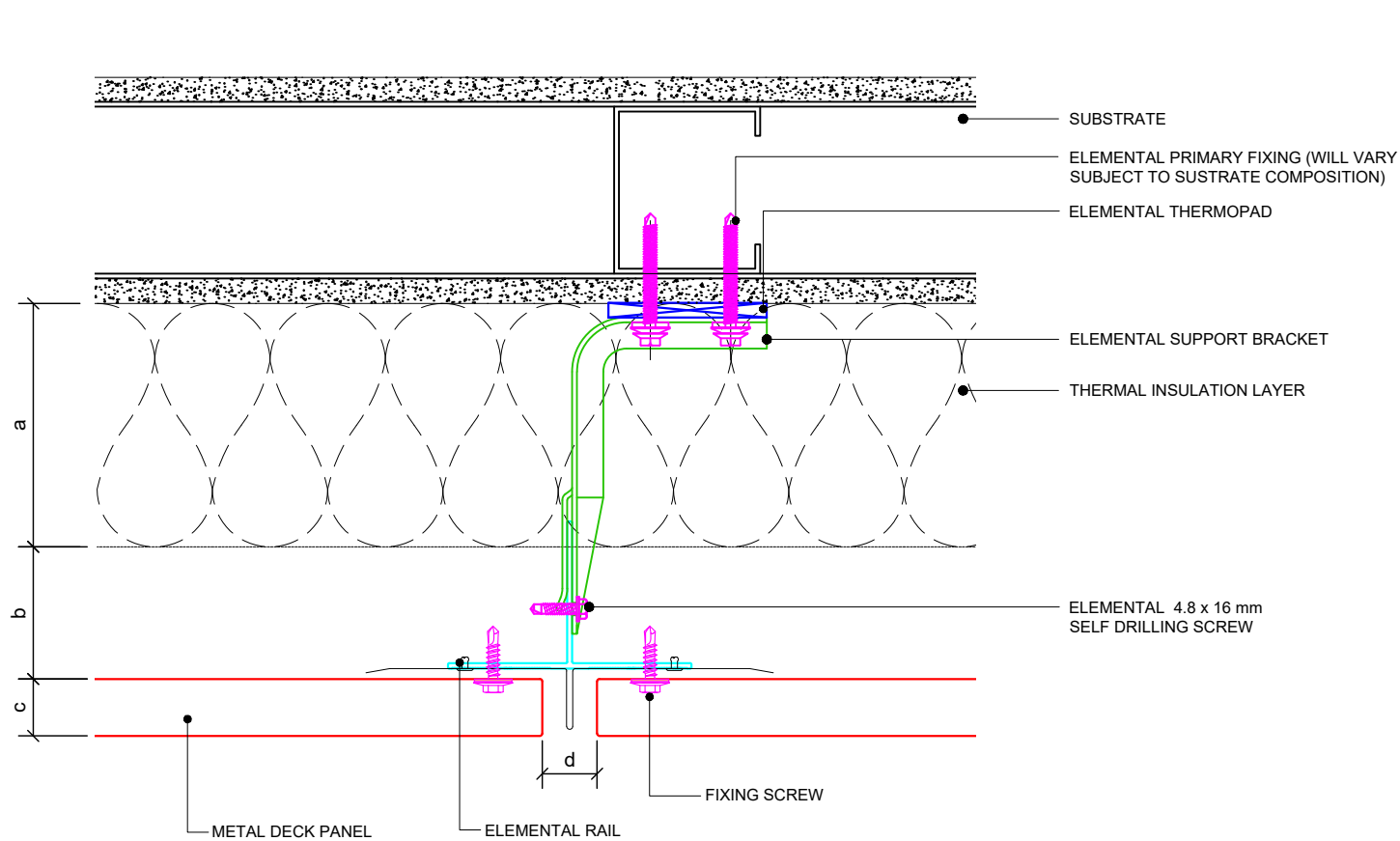

Dimensions	
a	Insulation thickness (varies)
b	Free vertical ventilation gap
c	Panel nominal thickness
d	Panel Joint - 10 mm min.
a+b	Clad Zone



Elemental Architectural Cladding Specialists
 #29 The Cubes Offices, Beacon South Quarter,
 Sandyford
 Dublin 18, D18 A264
 Phone: +353 (0)1 293 8951
 Email: info@elemental.ie

Drawing Title	ELEMENTAL METAL DECK - FACE FIX VERTICAL PANEL JOINT DETAIL										
Drawing No.	EL-SB-SHMD05	System:	EL-Screw Metal Deck	Size:	A4	Scale:	NTS	Drawn:	V.C.	Rev.	01

These drawings are indicative only, for use as a guide. The customer is always responsible for any specific design, structural calculations and calculating exact sizes & quantities of panels. Any project details and calculations supplied by Elemental Architectural Cladding Specialists are provided in good faith and should always be checked and approved by the project engineer responsible. Elemental Architectural Cladding Specialists will not accept any liability should the system be designed / installed incorrectly.

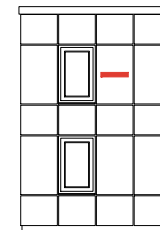
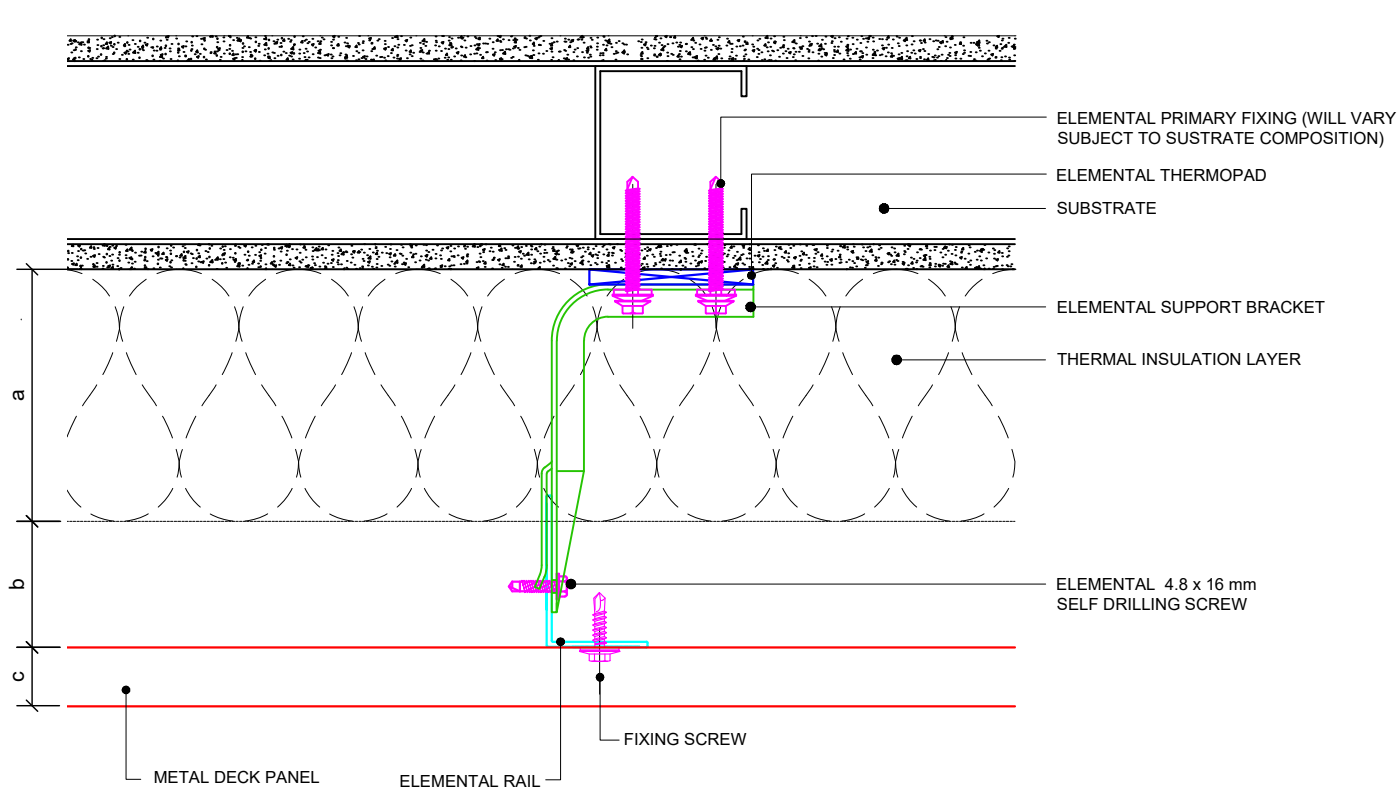

Dimensions	
a	Insulation thickness (varies)
b	Free vertical ventilation gap
c	Panel nominal thickness
a+b	Clad Zone



Elemental Architectural Cladding Specialists
 #29 The Cubes Offices, Beacon South Quarter,
 Sandyford
 Dublin 18, D18 A264
 Phone: +353 (0)1 293 8951
 Email: info@elemental.ie

Drawing Title	ELEMENTAL METAL DECK - FACE FIX INTERMEDIATE SUPPORT DETAIL										
Drawing No.	EL-SB-SHMD06	System:	EL-Screw Metal Deck	Size:	A4	Scale:	NTS	Drawn:	V.C.	Rev.	01

These drawings are indicative only, for use as a guide. The customer is always responsible for any specific design, structural calculations and calculating exact sizes & quantities of panels. Any project details and calculations supplied by Elemental Architectural Cladding Specialists are provided in good faith and should always be checked and approved by the project engineer responsible. Elemental Architectural Cladding Specialists will not accept any liability should the system be designed / installed incorrectly.

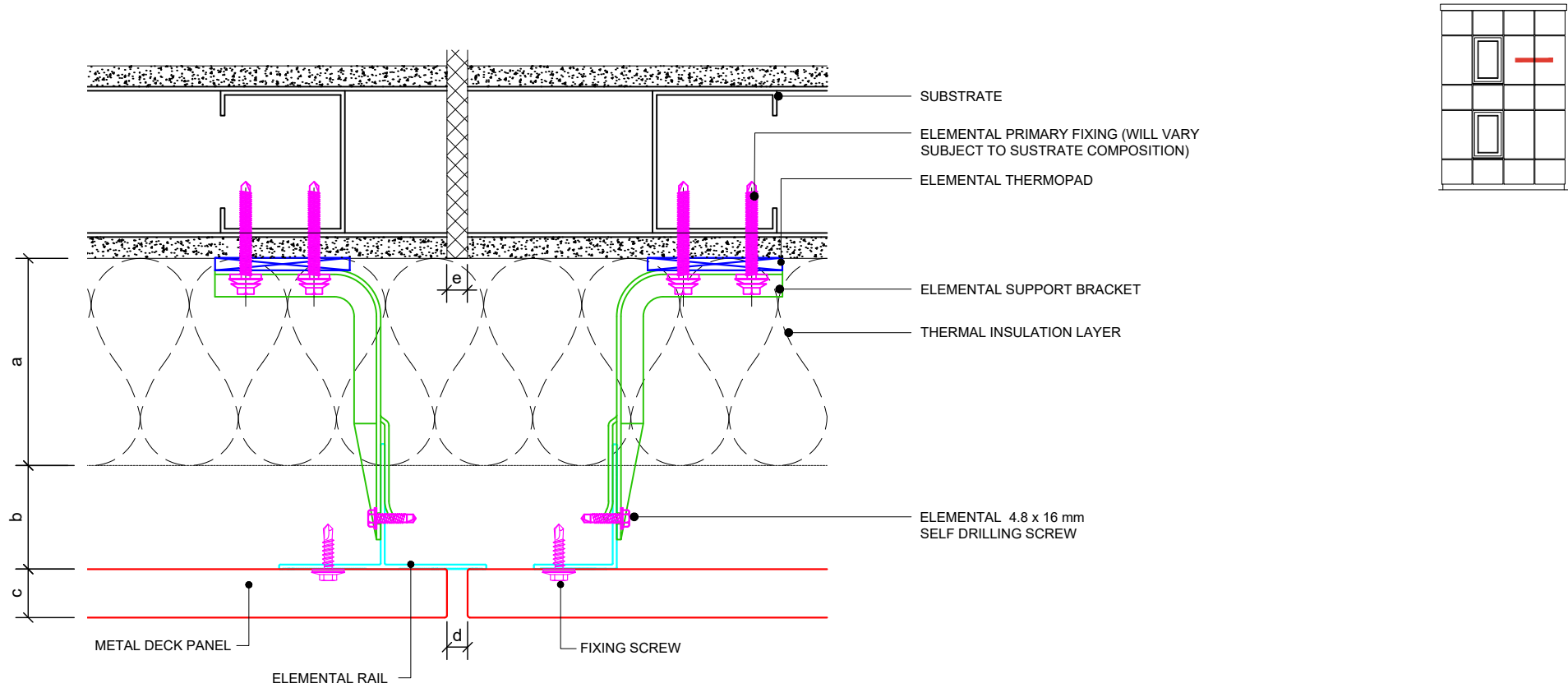

Dimensions	
a	Insulation thickness (varies)
b	Free vertical ventilation gap
c	Panel nominal thickness
d	Panel Joint - 8 mm min./ to match building movement joint
e	Building Structural Movement Joint
a+b	Clad Zone



Elemental Architectural Cladding Specialists
 #29 The Cubes Offices, Beacon South Quarter,
 Sandyford
 Dublin 18, D18 A264
 Phone: +353 (0)1 293 8951
 Email: info@elemental.ie

Drawing Title	ELEMENTAL METAL DECK - FACE FIX BUILDING STRUCTURAL MOVEMENT JOINT										
Drawing No.	EL-SB-SHMD07	System:	EL-Screw Metal Deck	Size:	A4	Scale:	NTS	Drawn:	V.C.	Rev.	01

These drawings are indicative only, for use as a guide. The customer is always responsible for any specific design, structural calculations and calculating exact sizes & quantities of panels. Any project details and calculations supplied by Elemental Architectural Cladding Specialists are provided in good faith and should always be checked and approved by the project engineer responsible. Elemental Architectural Cladding Specialists will not accept any liability should the system be designed / installed incorrectly.

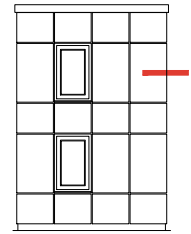
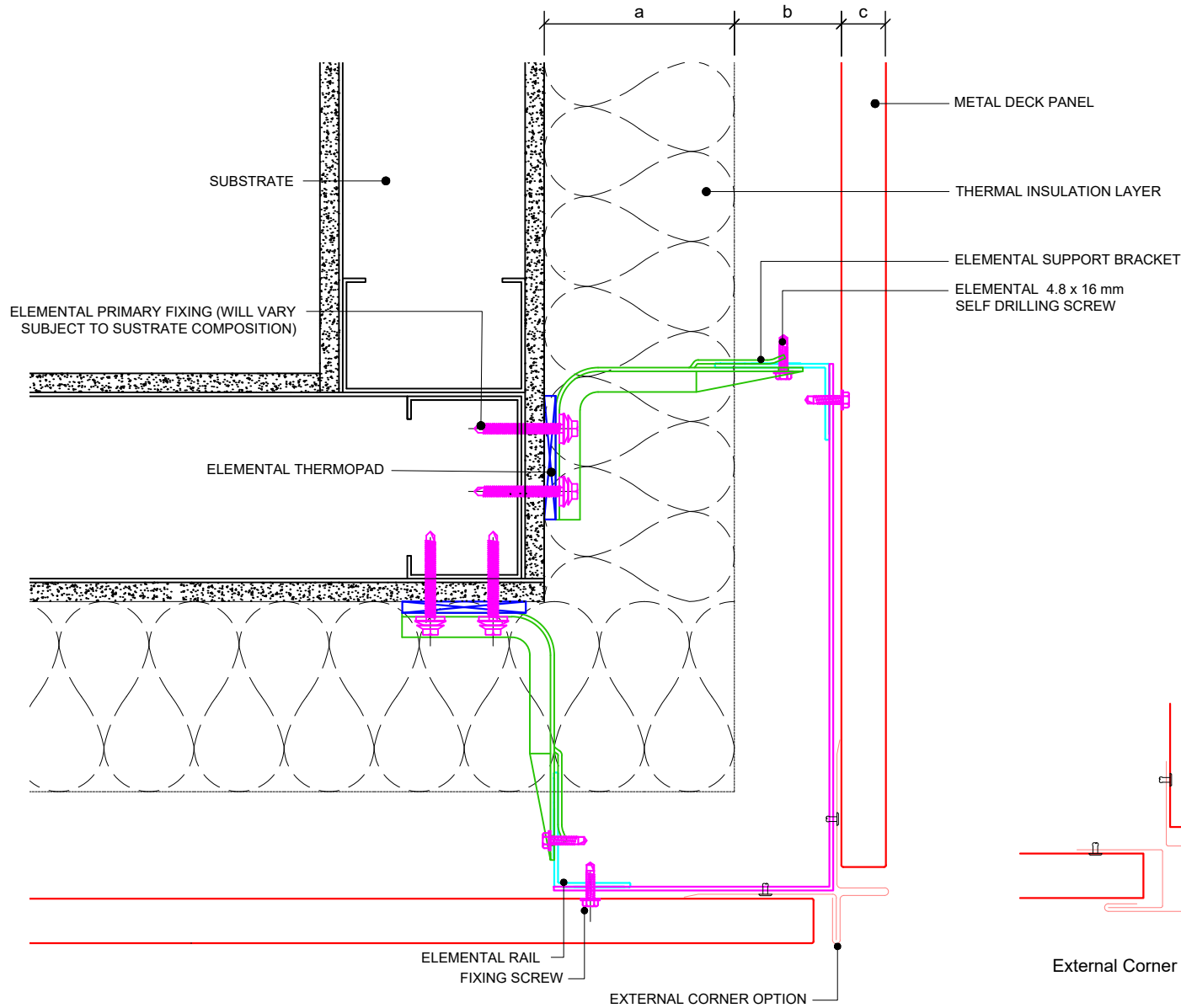

Dimensions	
a	Insulation thickness (varies)
b	Free vertical ventilation gap
c	Panel nominal thickness
a+b	Clad Zone

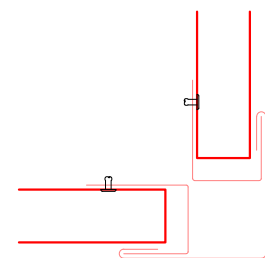

External Corner Option



Elemental Architectural Cladding Specialists
 #29 The Cubes Offices, Beacon South Quarter,
 Sandyford
 Dublin 18, D18 A264
 Phone: +353 (0)1 293 8951
 Email: info@elemental.ie

Drawing Title

**ELEMENTAL METAL DECK - FACE FIX
 EXTERNAL CORNER DETAILS**

Drawing No.

EL-SB-SHMD08

System:

**EL-Screw
 Metal Deck**

Size:

A4

Scale:

NTS

Drawn:

V.C.

Rev.

01

These drawings are indicative only, for use as a guide. The customer is always responsible for any specific design, structural calculations and calculating exact sizes & quantities of panels. Any project details and calculations supplied by Elemental Architectural Cladding Specialists are provided in good faith and should always be checked and approved by the project engineer responsible. Elemental Architectural Cladding Specialists will not accept any liability should the system be designed / installed incorrectly.

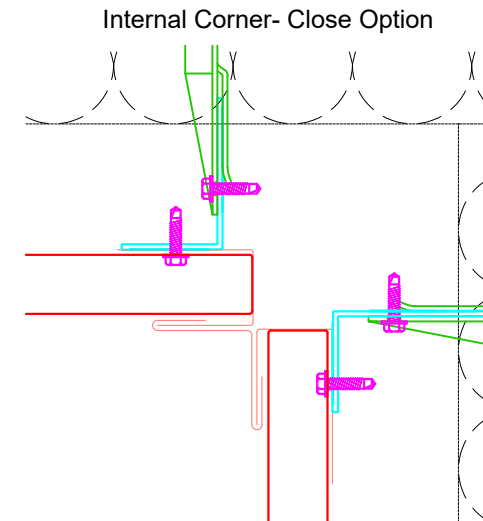
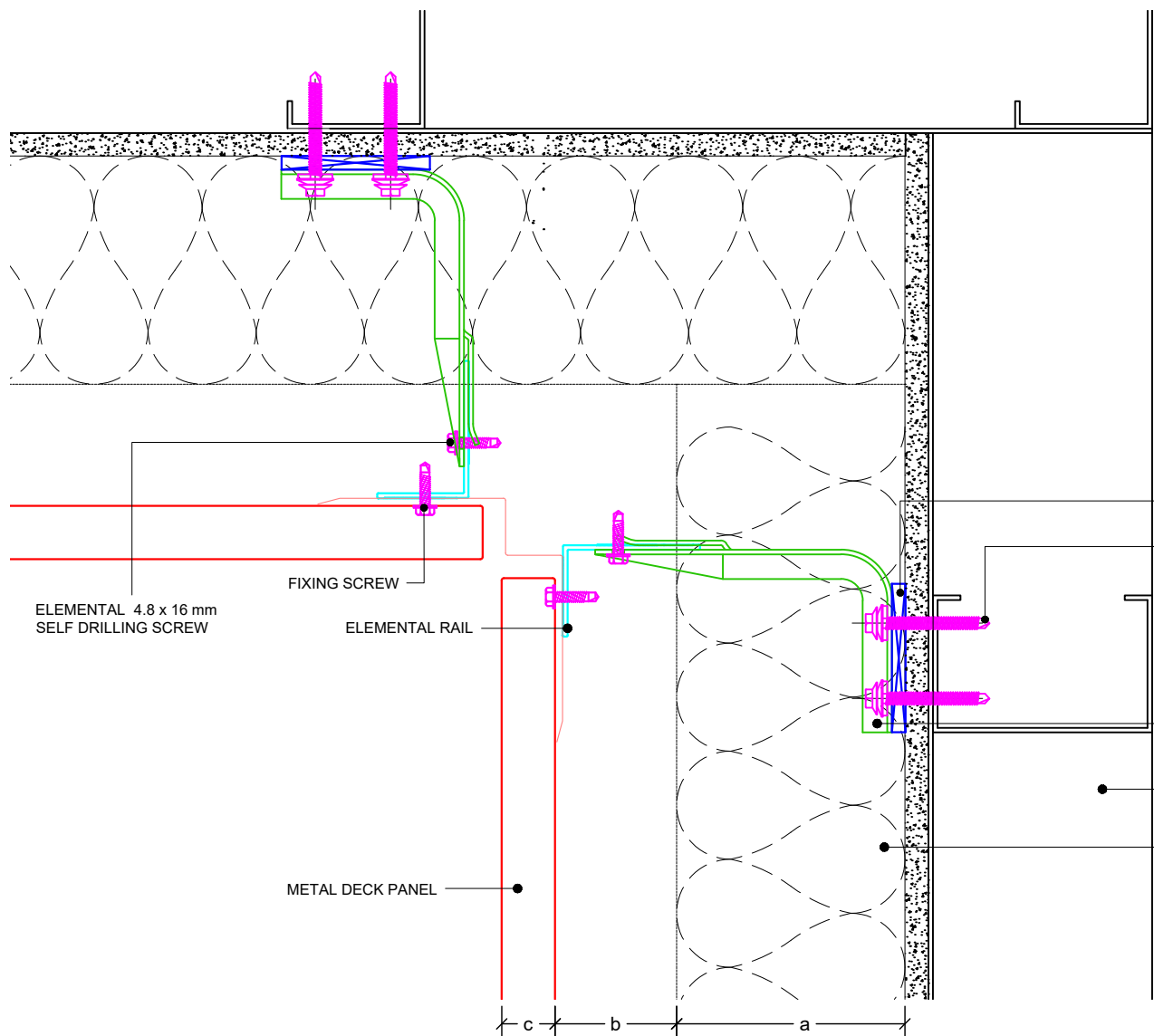

ELEMENTAL 4.8 x 16 mm SELF DRILLING SCREW

FIXING SCREW

ELEMENTAL RAIL

METAL DECK PANEL

ELEMENTAL THERMOPAD

ELEMENTAL PRIMARY FIXING (WILL VARY SUBJECT TO SUSTRATE COMPOSITION)

ELEMENTAL SUPPORT BRACKET

SUBSTRATE

THERMAL INSULATION LAYER

c b a

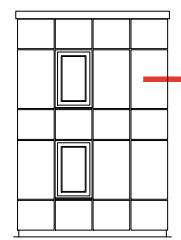

Dimensions	
a	Insulation thickness (varies)
b	Free vertical ventilation gap
c	Panel nominal thickness
a+b	Clad Zone



Elemental Architectural Cladding Specialists
 #29 The Cubes Offices, Beacon South Quarter,
 Sandyford
 Dublin 18, D18 A264
 Phone: +353 (0)1 293 8951
 Email: info@elemental.ie

Drawing Title	ELEMENTAL METAL DECK - FACE FIX INTERNAL CORNER-OPEN JOINT OPTION										
Drawing No.	EL-SB-SHMD09	System:	EL-Screw Metal Deck	Size:	A4	Scale:	NTS	Drawn:	V.C.	Rev.	01

These drawings are indicative only, for use as a guide. The customer is always responsible for any specific design, structural calculations and calculating exact sizes & quantities of panels. Any project details and calculations supplied by Elemental Architectural Cladding Specialists are provided in good faith and should always be checked and approved by the project engineer responsible. Elemental Architectural Cladding Specialists will not accept any liability should the system be designed / installed incorrectly.

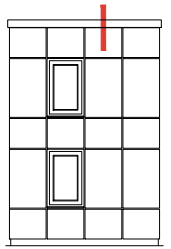
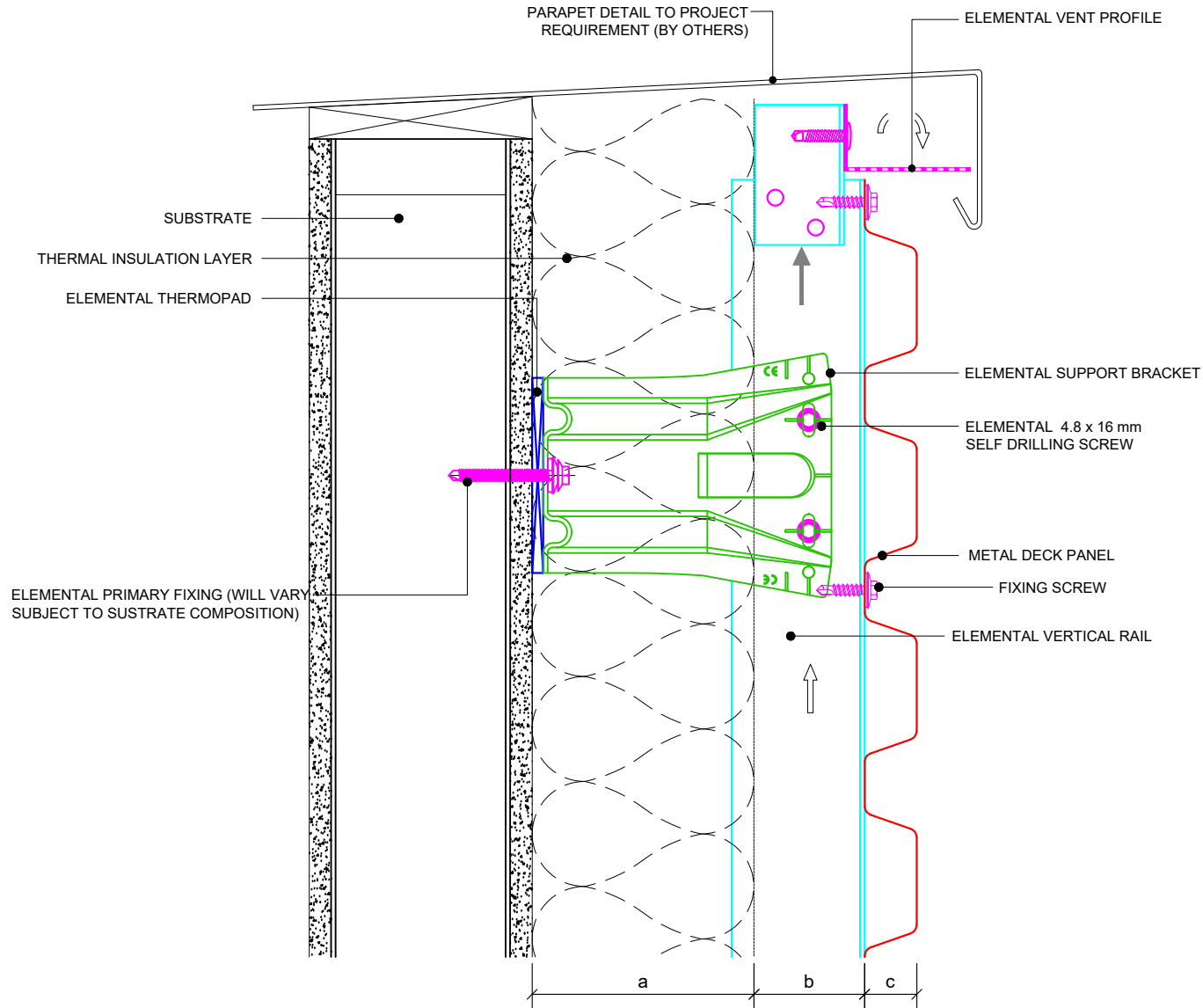

Dimensions	
a	Insulation thickness (varies)
b	Free vertical ventilation gap
c	Panel nominal thickness
a+b	Clad Zone



Elemental Architectural Cladding Specialists
 #29 The Cubes Offices, Beacon South Quarter,
 Sandyford
 Dublin 18, D18 A264
 Phone: +353 (0)1 293 8951
 Email: info@elemental.ie

Drawing Title	ELEMENTAL METAL DECK - FACE FIX GENERIC PARAPET DETAIL										
Drawing No.	EL-SB-SHMD10	System:	EL-Screw Metal Deck	Size:	A4	Scale:	NTS	Drawn:	V.C.	Rev.	01

These drawings are indicative only, for use as a guide. The customer is always responsible for any specific design, structural calculations and calculating exact sizes & quantities of panels. Any project details and calculations supplied by Elemental Architectural Cladding Specialists are provided in good faith and should always be checked and approved by the project engineer responsible. Elemental Architectural Cladding Specialists will not accept any liability should the system be designed / installed incorrectly.

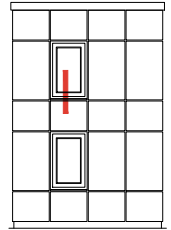
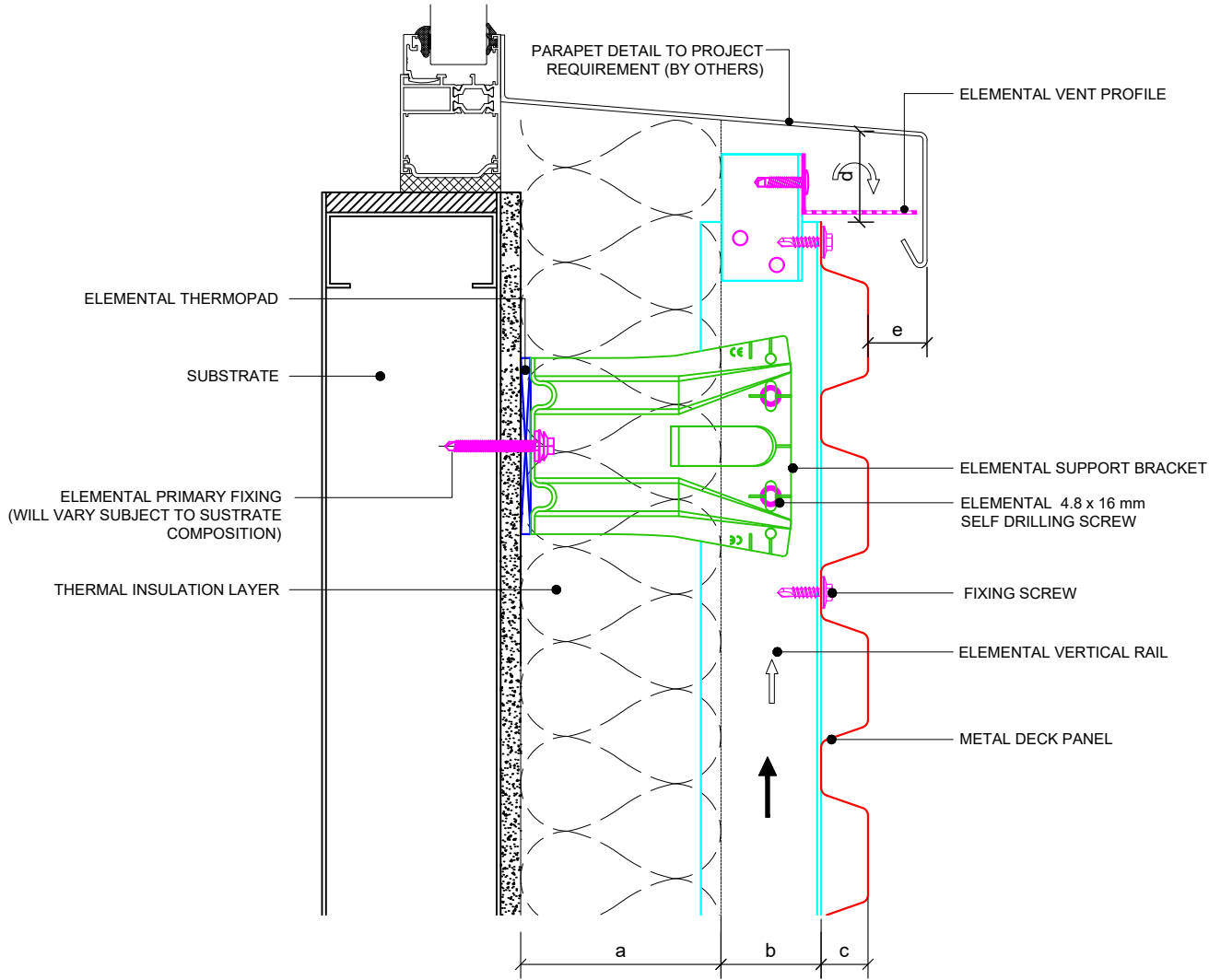

Dimensions	
a	Insulation thickness (varies)
b	Free vertical ventilation gap
c	Panel nominal thickness
d	Ventilation inlet / outlet gaps
e	≥ 40mm
a+b	Clad Zone



Elemental Architectural Cladding Specialists
 #29 The Cubes Offices, Beacon South Quarter,
 Sandyford
 Dublin 18, D18 A264
 Phone: +353 (0)1 293 8951
 Email: info@elemental.ie

Drawing Title

**ELEMENTAL METAL DECK - FACE FIX
 WINDOW CILL DETAIL**

Drawing No.

EL-SB-SHMD11

System:

**EL-Screw
 Metal Deck**

Size:

A4

Scale:

NTS

Drawn:

V.C.

Rev.

01

These drawings are indicative only, for use as a guide. The customer is always responsible for any specific design, structural calculations and calculating exact sizes & quantities of panels. Any project details and calculations supplied by Elemental Architectural Cladding Specialists are provided in good faith and should always be checked and approved by the project engineer responsible. Elemental Architectural Cladding Specialists will not accept any liability should the system be designed / installed incorrectly.

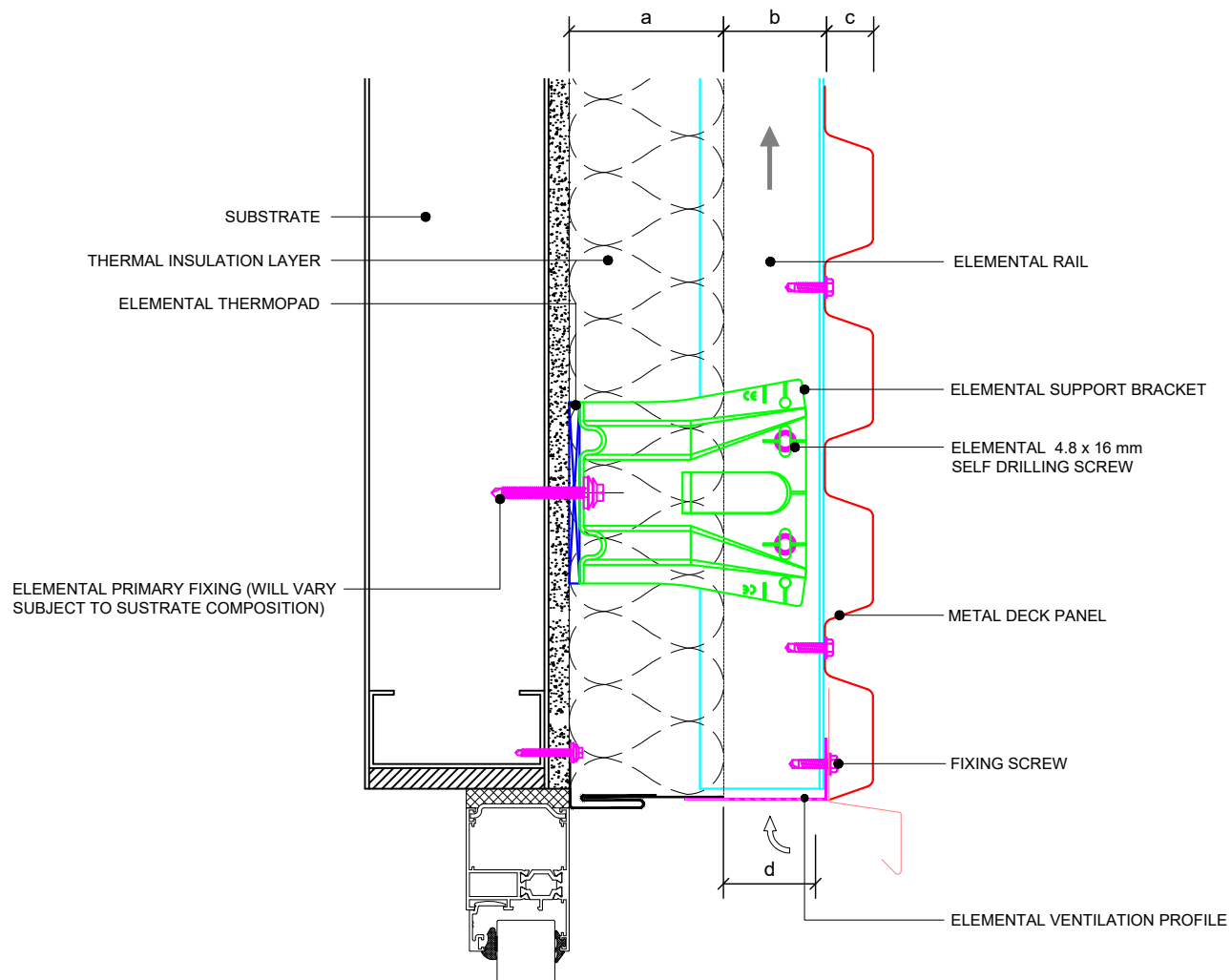

Dimensions	
a	Insulation thickness (varies)
b	Free vertical ventilation gap
c	Panel nominal thickness
d	Ventilation inlet / outlet gaps
a+b	Clad Zone



Elemental Architectural Cladding Specialists
 #29 The Cubes Offices, Beacon South Quarter,
 Sandyford
 Dublin 18, D18 A264
 Phone: +353 (0)1 293 8951
 Email: info@elemental.ie

Drawing Title

**ELEMENTAL METAL DECK - FACE FIX
 WINDOW HEAD DETAIL**

Drawing No.

EL-SB-SHMD12

System:

**EL-Screw
 Metal Deck**

Size:

A4

Scale:

NTS

Drawn:

V.C.

Rev.

01

These drawings are indicative only, for use as a guide. The customer is always responsible for any specific design, structural calculations and calculating exact sizes & quantities of panels. Any project details and calculations supplied by Elemental Architectural Cladding Specialists are provided in good faith and should always be checked and approved by the project engineer responsible. Elemental Architectural Cladding Specialists will not accept any liability should the system be designed / installed incorrectly.

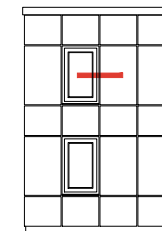
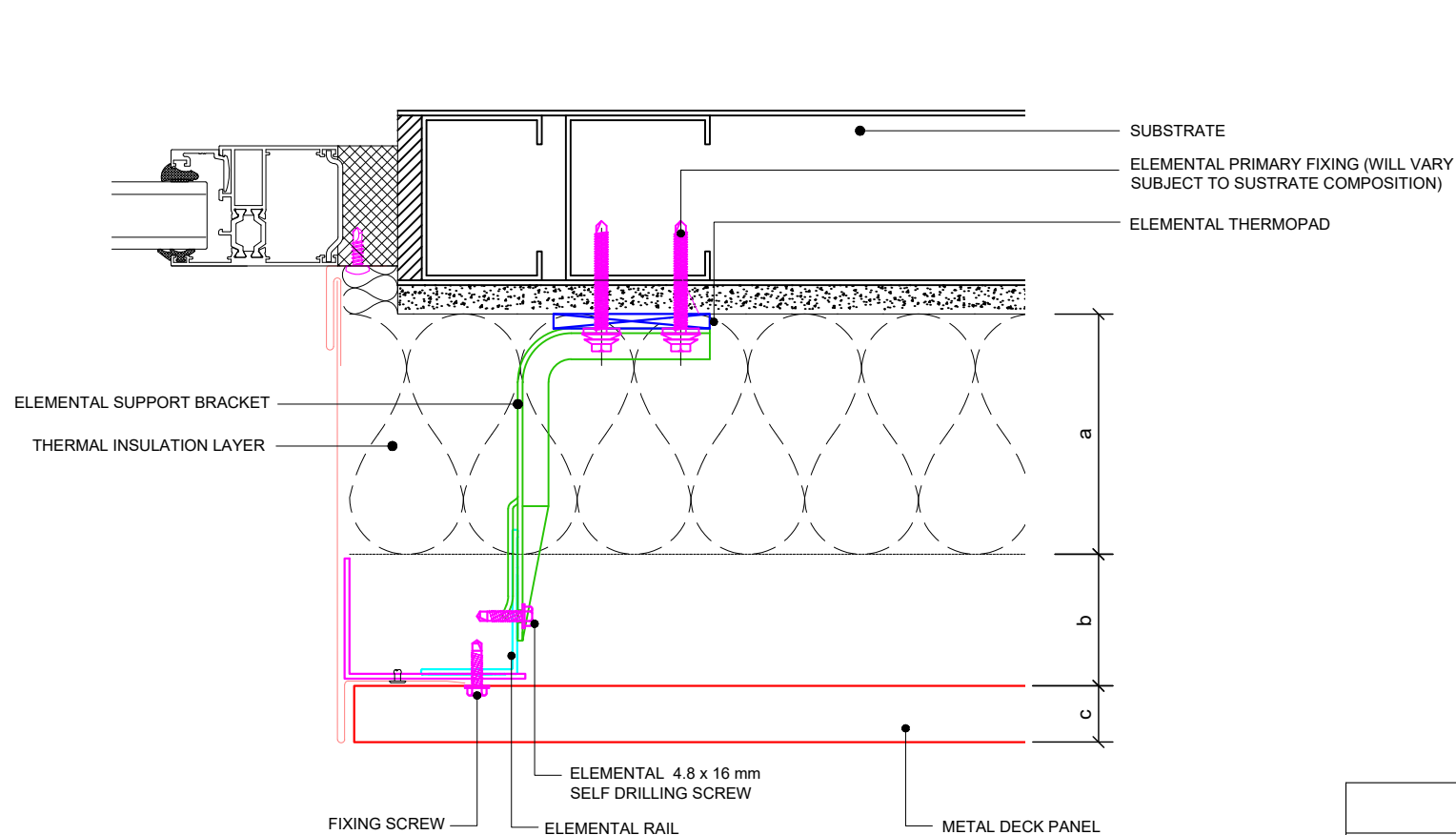

Dimensions	
a	Insulation thickness (varies)
b	Free vertical ventilation gap
c	Panel nominal thickness
a+b	Clad Zone



Elemental Architectural Cladding Specialists
 #29 The Cubes Offices, Beacon South Quarter,
 Sandyford
 Dublin 18, D18 A264
 Phone: +353 (0)1 293 8951
 Email: info@elemental.ie

Drawing Title

**ELEMENTAL METAL DECK - FACE FIX
 WINDOW JAMB REVEAL DETAIL**

Drawing No.

EL-SB-SHMD13

System:

**EL-Screw
 Metal Deck**

Size:

A4

Scale:

NTS

Drawn:

V.C.

Rev.

01